

MDS™ Master Station

Modular Communications Platform



TECHNICAL MANUAL

MDS 05-6399A01, Rev. E

AUGUST 2015

Firmware Version 3.1.0 and higher.



Digital Energy
MDS

Quick-Start instructions for this product are contained in publication 05-6398A01.

Visit our website for downloadable copies of all documentation at www.gemds.com.

IMPORTANT



This manual describes the details, installation, configuration and operation of the MDS™ Master Station. It does not cover the description or configuration of features and settings common to the MDS Orbit family of products. For full information on configuring the parts of the system that are not directly related to SD networking or the MDS™ Master Station, please reference the **MDS Orbit MCR Technical Manual (p/n: 05-6632A01)**. The MDS™ Master Station manual is designed to be used in parallel with the MCR Technical Manual, and as such does NOT cover information already described in that manual.

TABLE OF CONTENTS

1.0	<u>INTRODUCTION</u>	9
1.1	Organization of Manual.....	9
	Related Publications.....	10
2.0	<u>KEY PRODUCT FEATURES</u>	11
2.1	Accessories and Spare Items.....	12
2.2	Technical Specifications.....	14
2.3	FCC Emission Designators: How to Find Them.....	15
2.4	Front Panel.....	16
2.5	Rear Antenna Connections.....	17
3.0	<u>INSTALLATION PLANNING</u>	18
3.1	Applications.....	19
	Repeater and Polling Remote Operation.....	19
	Simplex and Switched Carrier Operation.....	19
3.2	Network Management.....	19
	Network-Wide Diagnostics.....	19
	Network Management Using PulseNET.....	19
3.3	Redundant versus Non-redundant Operation.....	20
3.4	Antennas and Feedlines.....	20
	Antennas.....	20
	Feedlines.....	20
3.5	Grounding Considerations.....	21
3.6	Data Interface Connections.....	22
	Ethernet Data Interface (RJ-45).....	22
	Serial Data Interfaces.....	22
	Serial Data Connection.....	22
	Mini USB.....	23
	Alarm Output and 4-Wire Audio.....	23
4.0	<u>INSTALLATION PROCEDURES</u>	24
4.1	Unpacking and Inspection.....	24
4.2	Installation Steps.....	24
	Initial Startup & Operation.....	27
	Module LED Indicators.....	28
	Normal Indications.....	28
	Maximizing RSSI.....	29
5.0	<u>DEVICE MANAGEMENT</u>	30



5.1	Pre-Configured Settings.....	30
5.2	One-Time “Recovery” Passwords.....	30
	One-Time Passwords: How They Work.....	30
	Creating a One-Time Password	31
	Logging in With a One-Time Password	31
	Deleting a One-Time Password.....	31
5.3	Configuration via Command Line (CLI).....	32
	Tab Completion Feature.....	32
	CLI Quick Reference Table	32
5.4	Interface Naming	34
5.5	Configuration via the Device Manager.....	34
	General Configuration	34
5.6	Interface Configuration	36
	Understanding	36
	Configuring	36
5.7	LAN.....	39
	Understanding	39
	Configuring	39
5.8	Bridging.....	42
	Understanding	42
	Configuring.....	42
5.9	SDMS Interface	42
	Understanding	42
	General.....	45
	Configuration	45
	General.....	46
	Dlink	50
	MAC Settings.....	51
	IP Payload	53
	IPv4	57
	Firewall Filter	58
	VLAN	58
	NAT	59
	Advanced	60
	Audio	63
	Enabled Alarms	64
	RTU Simulator	64
	Remote SD Reprogramming	64

Force Alarm	64
Link Test	65
Perform Failover	66
Remote Management Command.....	66
Remote SD Firmware	67
RF Key Test.....	67
Spectrum Analyzer	67
Remote SD Reprogramming	68
Monitoring.....	71
Statistics	71
Performance	73
IPv4 / IPv6	73
5.10 SD-x/0/0 Interfaces	73
General.....	73
Statistics	74
6.0 MASTER STATION MODULES.....	78
6.1 AC Power Supply Module	78
6.2 DC Power Supply Module.....	79
6.3 Platform Manager Module.....	80
Platform Manager LED Indicators.....	81
Ethernet Interfaces	81
COM1 Interface	82
COM2 Interface	82
Mini USB Interface.....	84
WiFi Antenna Interface (Optional)	85
GPS Antenna Interface (Optional).....	85
6.4 SD Master Radio Modules	85
SD Master Radio Module LED Indicators	85
SD Master Radio Module RF Interface.....	86
SDM9 Radio Module – 900MHz	86
SDM4 Radio Module - 400 MHz.....	86
6.5 Alarm and Alarm/Relay Modules	87
Alarm Module LEDs.....	88
Alarm/Audio Interface	88
Alarm/Relay Toggle Switch (6847 Only).....	89
Alarm/Relay RF Connections (6847 Only).....	89
6.6 Duplexer Tray	90
7.0 TROUBLESHOOTING	91



7.1	Interpreting Module LEDs	91
	Normal Operation	91
	Exception and Alarm States	92
7.2	Redundant Units	93
7.3	Technical Assistance	93
7.4	Replacing Modules	93
	Power Supply Modules	93
	Peripheral Modules – including Platform Manager, Radio, Alarm, and Alarm Relay Modules	94
	Hot Swap Redundant Modules	94
	Internal Duplexer Tray	95
	MDS SDM4—400 MHz Notch-Type Duplexers	95
	MDS SDM9—Bandpass-Type Duplexers	96
7.5	Testing and Removing an Internal Duplexer	96
	Testing	96
	Removing the Internal Duplexer	97
8.0	<u>TECHNICAL REFERENCE DATA.....</u>	100
8.1	RF Propagation Planning	100
	Fresnel Zone Clearance	100
	Formulas for System Planning	101
8.2	dBm-Volts-Watts Conversion Chart	103
9.0	<u>GLOSSARY OF TERMS & ABBREVIATIONS.....</u>	104

Copyright Notice

This Technical Manual and all software described herein are protected by copyright: 2015 GE MDS. All rights reserved.

GE MDS reserves its right to correct any errors and omissions in this publication.

Safety words and definitions

The following symbols used in this document indicate the following conditions:



Indicates a hazardous situation which, if not avoided, will result in death or serious injury.



Indicates a hazardous situation which, if not avoided, could result in death or serious injury.



Indicates a hazardous situation which, if not avoided, could result in minor or moderate injury.



Indicates practices not related to personal injury.



Indicates general information and practices, including operational information and practices that are not related to personal injury.

Installation & Servicing Precautions



The unit is provided for professional installation only, and utilizes a specialized antenna connector to restrict the types of antenna connections that may be made. The integrator of this device is responsible for compliance with all applicable limits on radiated RF power, and the RF power output may need to be adjusted to maintain compliance, depending on the gain of the antenna system.

All power supply main connections and disconnections must be made by a qualified electrical installer.

When servicing energized equipment, be sure to wear appropriate Personal Protective Equipment (PPE). During internal service, situations could arise where objects accidentally contact or short circuit components and the appropriate PPE would alleviate or decrease the severity of potential injury. When servicing radios, all workplace regulations and other applicable standards for live electrical work should be followed to ensure personal safety.

Operational Safety Notices

RF Exposure



The radio equipment described in this guide uses radio frequency transmitters. Although the power level is low, the concentrated energy from a directional antenna may pose a health hazard. Do not allow people to come in close proximity to the front of the antenna when the transmitter is operating. More information on RF exposure can be found online at the following website:

www.fcc.gov/oet/info/documents/bulletins

This manual is intended to guide a professional installer to install, operate, and perform basic system maintenance on the described radio.

⚠ CAUTION

The RF safety distance is calculated based on each product type’s highest output power configuration with no duplexer, redundant switching, or cable losses.

Table 1-1 Antenna Gain vs. Minimum RF Safety Distance

	Antenna Gain		
	0–5 dBi	5–10 dBi	10–16.5 dBi
Safety Distance SDM4 variant - FCC	1.09 meters	1.95 meters	4.11 meters
Safety Distance SDM4 variant – IC	1.43 meters	2.54 meters	5.37 meters
Safety Distance SDM9 variant – FCC	0.99 meters	1.76 meters	3.73 meters
Safety Distance SDM9 variant - IC	1.29 meters	2.30 meters	4.87 meters
Safety Distance (other models):	Consult factory prior to operation.		

Not all frequency models available. Consult factory for available models.

Antennas with gain greater than 16dBi have not been authorized for use with the EUT; and (b) installation of the EUT into portable applications with respect to RF compliance will require SAR testing and Regulatory approval.

CSA Notice

⚠ CAUTION Units (Both AC and DC supply versions) are permanently connected to Protective Earth, via ground stud on the unit enclosure back, where the final installation is subject to acceptance of CSA International or the local inspection authority having jurisdiction.

Conditions of Acceptability:

1. The equipment shall be installed indoors in a restricted access location.
2. Installation of the equipment and its modules shall be conducted by trained personnel in accordance with the electrical code.
3. This equipment is movable, Class I (earthed), pluggable Type A, using detachable power cords, intended for use on TN or TT power system for the AC power option.
4. The DC power option shall be connected to an approved power source with adequate protection, isolated from the mains by reinforced insulation.

5. This product was certified for use on a 20A branch circuit for the AC power option.
6. The AC socket outlet shall be installed near the equipment and shall be easily accessible.
7. The power supply cord must be disconnected from the appliance inlet before removing any power supply from the chassis.
8. CAUTION: THIS UNIT HAS MORE THAN ONE POWER SUPPLY CORD. DISCONNECT THE TWO POWER SUPPLY CORDS BEFORE SERVICING TO AVOID ELECTRIC SHOCK
9. The equipment chassis shall be permanently grounded though a size six screw and a star toothed washer.
10. The interior of the equipment is not for operator access.

 **WARNING**

FCC Part 15 Notice

This Equipment has been tested and found to comply with the limits for a Class A digital device, pursuant to Part 15 of the FCC Rules. These limits are designed to provide reasonable protection against harmful interference when the equipment is operated in a commercial environment. This equipment generates, uses, and can radiate radio frequency energy and, if not installed and used in accordance with the instruction manual, may cause harmful interference to radio communications. Operation of this equipment in a residential area is likely to cause harmful interference in which case users will be required to correct the interference at their own expense.

This device complies with Part 15 of the FCC Rules. Operation is subject to the following two conditions: (1) this device may not cause harmful interference, and (2) this device must accept any interference received; including interference that may cause undesired operation.

Warning: Changes or modifications not expressly approved by the manufacturer could void the user's authority to operate the equipment

Canada, IC ERP Limits

IC SRSP-501, 6.3.2. Limits the ERP to 125W for fixed point-to-point operation. For IC use, the antenna gain and Transmit power must be set to meet the ERP limit of 125W. This can be accomplished by using the appropriate antenna gain in combination with the RF power settings

Environmental Information

 The equipment that you purchased has required the extraction and use of natural resources for its production. Improper disposal may contaminate the environment and present a health risk due to hazardous substances contained within. To avoid dissemination of these substances into our environment, and to diminish the demand on natural resources, we encourage you to use the appropriate recycling systems for disposal. These systems will reuse or recycle most of the materials found in this equipment in a sound way. Please contact GE MDS or your supplier for more information on the proper disposal of this equipment.

ISO 9001 Registration

GE MDS adheres to this internationally-accepted quality system standard.

Quality Policy Statement

We, the employees of GE MDS, are committed to achieving total customer satisfaction in everything we do.

Total Customer Satisfaction in:

- Conception, design, manufacture, and marketing of our products.
- Services and support we provide to our internal and external customers.

Total Customer Satisfaction Achieved Through:

- Processes that are well documented and minimize variations.
- Partnering with suppliers who are committed to providing quality and service.
- Measuring our performance against customer expectations and industry leaders.
- Commitment to continuous improvement and employee involvement.

Revision Notice

While every reasonable effort has been made to ensure the accuracy of this manual, product improvements may result in minor differences between the manual and the product shipped to you. If you have additional questions or need an exact specification for a product, please contact our Customer Service Team using the information at the back of this guide. In addition, manual updates can often be found on our Web site at www.gemds.com.

ESD Notice

To prevent malfunction or damage to this radio, which may be caused by Electrostatic Discharge (ESD), the radio should be properly grounded by connection to the ground stud on the rear panel. In addition, the installer or operator should follow proper ESD precautions, such as touching a grounded bare metal object to dissipate body charge, prior to connecting and disconnecting cables on the front or rear panels.

Open Source License Declaration

Orbit MCR products include Open Source Software. Usage is governed by the corresponding licenses which are listed on the GE MDS Industrial Wireless website, under Orbit MCR *Software/Firmware Downloads, Support Items* and download **license-declaration.txt**.

Upon request, in accordance with certain software license terms, GE will make available a copy of Open Source code contained in this product. This code is provided to you on an “as is” basis, and GE makes no representations or warranties for the use of this code by you independent of any GE provided software or services. For more information, contact gemds.techsupport@ge.com.

1.0 INTRODUCTION

The MDS™ Master Station is an advanced, flexible platform designed for the demanding requirements of today's industrial wireless networks. It represents the latest development in a line of MDS products that set the standards for wireless performance today. The Master Station builds on this legacy with several innovative features, including a single compact chassis (2 RU), 100% duty cycle operation (no cooling fans required), front panel access to all modules, and drop-in compatibility with earlier MDS x790/x710 radio systems.

As the central station in a wireless network, the Master Station provides uncompromised performance and reliability in mission-critical applications. It offers redundant protection of key modules, automatic switchover in the event of a fault, and an external battery backup option for continued operation through temporary power losses. The Master Station mounts conveniently in a 19-inch rack cabinet, or may be used in shelf/tabletop configurations.



Figure 1-1. MDS™ Master Station

The Master Station can be configured for a variety of service applications, including Point-to-Multipoint SCADA, Point-to-Point links, broadband, and Cellular connectivity, depending on the modules installed and active in the chassis.

In FCC part 90 SCADA service, the radio can function as a Master, Repeater, or Remote and is capable of full duplex operation. Internal duplexer options are available, configured for use with or without an external notch filter. Provisions for connection to an external duplexer are also provided. The Master Station is fully compatible with MDS PulseNET management software, which provides local or remote diagnosis and health reporting.

1.1 Organization of Manual

This manual is intended for use by systems engineers, network administrators, and others responsible for the planning, installation, commissioning, use, and troubleshooting of the wireless system. The manual begins with an overall description of product features, and is followed by the steps required to install the unit and place it into normal operation.

Following the installation procedures, sections are devoted to particular modules that may be installed in the chassis, including configuration settings for each of these units. Additionally, troubleshooting tips for resolving system difficulties are offered, as well as a technical reference section with data on wiring, specifications, and spare parts that may be ordered for the unit.

When installation and setup of the radio is complete, it is recommended that this guide be kept available for future reference at the installation site. Updated manuals, firmware, and other support documents may be obtained at any time from our website: www.gemds.com.

Related Publications

In addition to this manual, a companion *Setup Guide* is available for the MDS™ Master Station, Part No. 05-6398A01. The Setup Guide is focused on the essential steps for installation and startup of the unit, and is designed to be used with this Technical Manual.

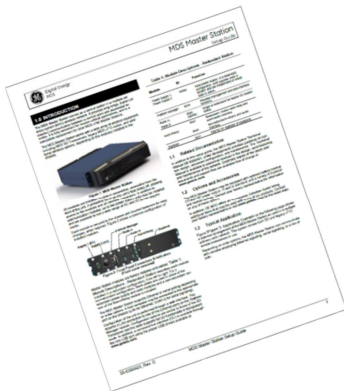

The MDS™ Master Station Setup Guide, Part No. 05-6398A01 contains basic installation and startup instructions for the product.

All GE MDS user manuals and updates are available online at www.gemds.com.

The MDS™ Master Station is built on the Orbit platform. For reference information on advanced networking features available on the local LAN Interface, refer to the **MDS Orbit MCR Technical Manual (05-6632A01)**. Note that not all features are supported by the Master Station or the SD Radio Module. Wireless networking capabilities are limited by the narrowband channel and the capabilities of the remote radio.

2.0 KEY PRODUCT FEATURES

As a licensed, long range IP/Ethernet and serial communications device, the Master Station exceeds industry standards for reliability and performance in wireless networks. Listed below are several key features and benefits of the product, and these are available with the appropriate modules installed and configured in the chassis.

- Drop-in replacement for earlier MDS x790 Master Stations, including support for all modem types
- Backward compatibility with all legacy MDS x710 Series remote transceivers (A and B modems)
- May be operated as a Master Station, repeater, or remote radio
- Supports use of MDS™ PulseNET Network Management Software
- Software-configurable via a built-in web-based device manager—no manual adjustments required
- Firmware-upgradeable for future improvements and functionality enhancements
- Available encryption of payload data (AES 128-bit), for networks using all-SD radios
- Dual serial functionality (RS-232 and RS-485)
- Licensed 10-watt radio design ensures minimum 5-watts at the duplexer output, and maximizes communications range with low interference risk from other users
- RF power adjustable; 1-10 watts at output of radio card (before relay & duplexer)
- Unit is configurable via software, locally or remote
- Media Access Control (MAC) to prevent data collisions when two or more radios attempt to use the radio channel at the same time
- Supports a wide variety of modem speeds and bandwidths for regulatory compliance in virtually all regions of the world (future availability)



Some features may not be available on all units, depending on the options purchased and regulatory constraints for the region in which the radio will operate.



Figure 2-1 Compatible Remotes

The Master Station works with legacy MDS x710 (left), and newer MDS SD Transceivers.

2.1 Accessories and Spare Items

The following table lists common accessories and spare items for use with the Master Station. GE MDS also offers an *Accessories Selection Guide* listing an array of additional items available for use with the product. Contact your factory representative or visit www.gemds.com to obtain a copy of the guide.

Table 2-1. Accessories and Spares

Item	Description	Part Number
Three-conductor DC power plug	Mates with power connector on the front of the unit's DC power supply module. Screw terminals are provided for wires, and threaded locking screws to prevent accidental disconnect.	73-1194A22
Setup Guide (for installation & basic startup)	Brief document describing the installation and setup of the unit. One copy normally supplied with each unit. Additional PDF copies available (no charge) from www.gemds.com .	05-6398A01
COM Port Adapter	Converts the unit's RJ-45 serial jack to a DB-9F type.	73-2434A25
Mini USB 2.0 Cable, 3 ft./0.91 meter length	USB Type A (M) to mini-USB Type B (M) cable to provide console access through the radio's mini USB connector.	97-6694A05
Lightning Protectors	Polyphaser Surge Protector, IS-50NX-C2, DC blocked, 125 MHz to 1000 MHz, N-female connectors, surface (flange) mount	97-1680A01
	Polyphaser Surge Protector, IS-B50LN-C2, DC blocked, 125 MHz to 1000 MHz, N-female connectors, bulkhead mount	97-1680A05
Cavity Filter Kit	Removes or attenuates interfering 900 MHz signals from the receiver input. Might be necessary in areas with high powered stations nearby, such as paging transmitters. Requires tuning to a particular frequency. Available for use with an internal or external duplexer.	03-3621Axx
Alarm & Audio Cable	Cable connects to 6847/6848 Alarm/Relay Modules to provide access to four wire audio, push to talk, analog RSSI, and Major/Minor alarm dry contacts	03-6940A01
External Battery Kit	2U rack mounted UPS battery backup. Connects to 03-6755A02 AC power module.	
	UPS, 120V, 1.5kVA, 900W, 2U – UL/CSA for North America	97-4444A01
	UPS, 230V, 1.5kVA, 900W, 2U – CE Marked for Europe	97-4444A02
100-220 AC Power Supply Module	100-220 VAC, 50/60 Hz. 120W Max AC Power Supply Module. Spare power supply can be used in either of two power supply slots of the MDS™ Master Station.	03-6755A02
+/- 12-36 VDC Power Supply Module	+/- 12-36 VDC. 10 A Max. DC Power Supply Module. Spare power supply can be used in either of two power supply slots of the MDS™ Master Station.	03-6843A01
+/- 36-75 VDC Power Supply Module	+/- 36-75 VDC. 3.5 A Max DC Power Supply Module. Spare power supply can be used in either of two power supply slots of the MDS™ Master Station.	03-6844A01
+/- 75-140 VDC Power Supply Module	+/- 75-140 VDC. 2 A Max DC Power Supply Module. Spare power supply can be used in either of two power supply slots of the MDS™ Master Station.	03-6845A01
Platform Manager Module	Provides management and data interface functions.	03-6834A01A



Table 2-1. Accessories and Spares

Item	Description	Part Number
SDM9 Module	9C-band full duplex radio: 928-960MHz FCC Part 24, 101	03-6846A01-9C
	9K-band full duplex radio: TX 928-960MHz / RX 880-915MHz FCC Part 24, 101, 90	03-6846A01-9K
SDM4 Module	B-band full duplex radio: 400-450MHz FCC Part 22, 90, CE	03-6846A01-4B
	C-band full duplex radio: 450-512MHz FCC Part 22, 90, CE	03-6846A01-4C
Redundant Alarm/Relay Module	Active radio relay and alarm/audio interface.	03-6847A01
Non-Redundant Alarm Module	Non-redundant—alarm and audio interface.	03-6848A01
Duplexers for 9C-Band Radios	Spare duplexer in tray wired for MDS™ Master Station.	
	9 MHz (932.0-932.5) / (941.0-941.5), COMBINED OUT	03-6837D9B1
	24 MHz (928.0-929.0) / (952.0-953.0), COMBINED OUT	03-6837D9C1
	31 MHz (928.0-929.0) / (959.0-960.0), COMBINED OUT	03-6837D9D1
	9 MHz (932.0-932.5) / (941.0-941.5), RX OUT, RX IN, COMBINED OUT	03-6837D9B3
	24 MHz (928.0-929.0) / (952.0-953.0), RX OUT, RX IN, COMBINED OUT	03-6837D9C3
Duplexers for 9K-Band Radios	Spare duplexer in tray wired for MDS Master Station.	
	39 MHz (896.0 - 898.0) / (935.0 - 937.0) COMBINED OUT	03-6837D9E1
Duplexers for SDM4 Radios	Spare duplexer in tray wired for MDS Master Station.	
	5-10 MHz Split (350 - 512MHz) COMBINED OUT	03-6837D411
Front Cable Replacements	5-10 MHz Split (350 - 512MHz) RX OUT, RX IN, COMBINED OUT	03-6837D413
	Non-Redundant Radio to Duplexer: SMA MALE TO SMB FEMALE	03-4528A07
	Redundant Relay to Duplexer: SMA MALE TO SMB FEMALE	03-4528A07
	Redundant Radio to Relay: SMB FEMALE TO SMB FEMALE	03-4528A08

2.2 Technical Specifications

The following are the key operating specifications for the SD Master Station 900MHz and 400MHz variants. Items are separated into Transmit (TX) and Receive (RX) categories. Ongoing product improvements may result in specification changes, and GE MDS reserves the right to make such changes without obligation to any party. Should you require an exact specification for the build of your unit, please contact the factory for additional assistance.

Table 2-2. 900MHz Master Station Technical Specifications

Transmit (TX) Parameter	Specification
Frequency Range	928-960 MHz (SDM9C, SDM9K) ¹
Frequency Stability	<0.5 ppm, -30°C to +60°C
TX Power Out	+40.25 dBm +/-0.85dB at radio card for -30°C to +60° C ¹ +37 dBm +1.85/-0.85 dB at back of chassis -30°C to +60°C ¹
TX Frequency Response	+/- 1.0 dB from 100 Hz to 2.5 kHz
Agency Approvals	FCC Part 24D FCC Part 101C IC RSS 119
Load VSWR	10:1 Max, All angles, No damage
Power Consumption	<80W for all DC and AC versions, 100% TX Duty Cycle
Receive (RX) Parameter	Specification
Frequency Range	928-960 MHz (SDM9C), 880-915 MHz (SDM9K)
RX Intermodulation	>60 dB
RX Adjacent Channel	>60 dB
RX Spurious and Image	>60 dB when operating with integrated bandpass duplexer
RX Baseband Amplitude	225 < Audio Level <275 mV RMS, -50 dBm @ 1 kHz
RSSI Accuracy	+/-3 dB for RSSI -110 to -70 dBm
RX High RF Input Level	10 dBm, no damage
RX Baseband Frequency Response	+/- 1.0 dB from 100 Hz to 2.5 kHz
Power Consumption	<30W for all DC and AC versions, transmitter disabled
Noise Figure	<6 dB
Blocking	>60 dB
Operating Range	-30°C to +60°C

¹ Additional frequency bands under development

² -30°C to +50°C when operating continuously keyed (CKEY)

Table 2-3. 400MHz Master Station Technical Specifications

Transmit (TX) Parameter	Specification
Frequency Range	400-450 MHz (SDM4B) 450-512MHz (SDM4C) ¹
Frequency Stability	<0.5 ppm, -30C to +60C
TX Power Out	+41.1 dBm maximum at radio card for -30 to +60C ²
TX Frequency Response	+/- 1.0 dB from 100 Hz to 2.5 kHz
Agency Approvals	FCC Part 22
	FCC Part 90
	IC RSS-119
Load VSWR	10:1 Max, All angles, No damage
Power Consumption	<80W for all DC and AC versions, 100% TX Duty Cycle
Receive (RX) Parameter	Specification
Frequency Range	400-450 MHz (SDM4B) 450-512MHz (SDM4C)
RX Intermodulation	>60 dB
RX Adjacent Channel	>60 dB
RX Spurious and Image	>60 dB
RX Baseband Amplitude	225 < Audio Level <275 mV RMS, -50 dBm @ 1 kHz
RSSI Accuracy	+/-3 dB for RSSI -110 to -70 dBm
RX High RF Input Level	10 dBm, no damage
RX Baseband Frequency Response	+/- 1.0 dB from 100 Hz to 2.5 kHz
Power Consumption	<30W for all DC and AC versions, transmitter disabled
Noise Figure	<6 dB
Blocking	>60 dB
Operating Range	-30°C to +60°C

¹ Additional frequency bands under development

² -30°C to +50°C when operating continuously keyed (CKEY)

2.3 FCC Emission Designators: How to Find Them

An FCC emission designator is a seven-character string that represents the bandwidth, modulation, and other characteristics of a transmitted radio signal. This information is required when applying for an FCC license. The designator assigned to your equipment depends on the particular sub-model of the product line you are licensing. In some cases, multiple designators are used to cover product variants such as base stations, remotes, indoor/outdoor units, frequency band, etc. An updated and official list of emission designators is maintained on the FCC's website at the following link: <https://apps.fcc.gov/oetcf/eas/reports/GenericSearch.cfm>

Once the site has been reached, proceed as follows to determine your designator:

1. At the top of form in the box labeled Grantee Code: enter **E5M**. This is the code for GE MDS products.
2. At the bottom of the form in the box labeled **Show x Records at a Time**, enter a sufficiently large number (*i.e.*, **300**) to display all GE MDS records on file. Press Enter.



3. Once the list appears, it can be searched to locate the particular model you are seeking information on. To the left of each entry, there is a document icon. Click the icon to display the equipment authorization report.
4. Scroll down to the section labeled **Equipment Specifications** to locate the appropriate emission designator. If additional assistance is required, contact GE MDS using the information given at the end of this manual.

2.4 Front Panel

All access to Master Station modules is made from the front of the unit after removing the protective cover. To remove the cover, simply grasp the sides and pull out with a slight rocking motion. Tether strips on the ends of the cover are available to keep it linked to the chassis when it has been removed from its installed position. The tethers allow the cover to rest just below the front panel during service work.

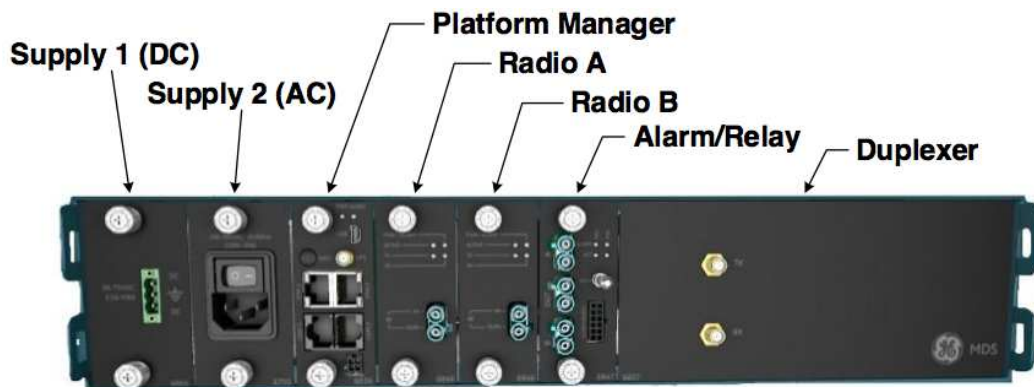

Figure 2-2. MDS™ Master Station, Front Panel Connections & Indicators
(Representative arrangement; Module types vary based on product configuration)

Master Station modules are factory installed and cabled. All modules are installed on slide-in assemblies and secured to the chassis with knurled fasteners. The illustration below shows the modules installed in a redundant configuration. For a non-redundant configuration, blank plates are used in place of the redundant power supply and radio modules, and a *non*-redundant version of the Alarm/Relay module will be installed. The table that follows lists the module types available as of the date of publication.

Table 2-4. Module Descriptions

Module Name	ID	Function
Power Supply 1 Power Supply 2	6843: (+/- 12-36 VDC) 6844: (+/- 36-75 VDC) 6845: (+/- 75-140 VDC) 6755: (110/220 VAC)	Provides operating power based on a variety of AC and DC input options. Up to two power supply modules may be installed in the chassis (AC or DC; any combination. In a redundant configuration, both power supplies work in tandem and are independent of which radio is currently active.
Platform Manager	6834	Provides management and data interface functions.
Radio A Radio B	6846 (SDM9, SDM4)	Single or redundant full duplex SD Master radios.
Alarm/Relay Module Alarm Module	6847 6848	Redundant—Active radio RF relay and alarm/audio interface. Non-redundant—Alarm and audio interface.
Duplexer	6837	Internal RF duplexer (if equipped). Allows simultaneous transmission and reception of signals on separate TX/RX frequencies, using a single antenna.

2.5 Rear Antenna Connections



**Figure 2-3. MDS™ Master Station, Rear Panel
Showing Antenna Connection & Heatsink**

(Other configurations possible for external items such as duplexer or cavity filter)

3.0 INSTALLATION PLANNING

This section covers pre-installation factors that should be considered when installing the Master Station. Careful planning will help achieve optimal performance from the radio. After reviewing this section, refer to the step-by-step installation procedures beginning on Page 24.

The specific details at an installation site may vary, but there are three main requirements for installing the unit in all cases:

- Adequate and stable primary power
- An efficient and properly installed antenna system
- Correct interface connections between the Master Station and any connected equipment.

Figure 3-1 shows a common arrangement of the Master Station as used in a multiple address radio network. The system shows both SD and legacy x710 remote transceivers in use. Depending on order options, the Master Station can communicate with remotes employing Ethernet signaling, serial signaling, or a mix of both.

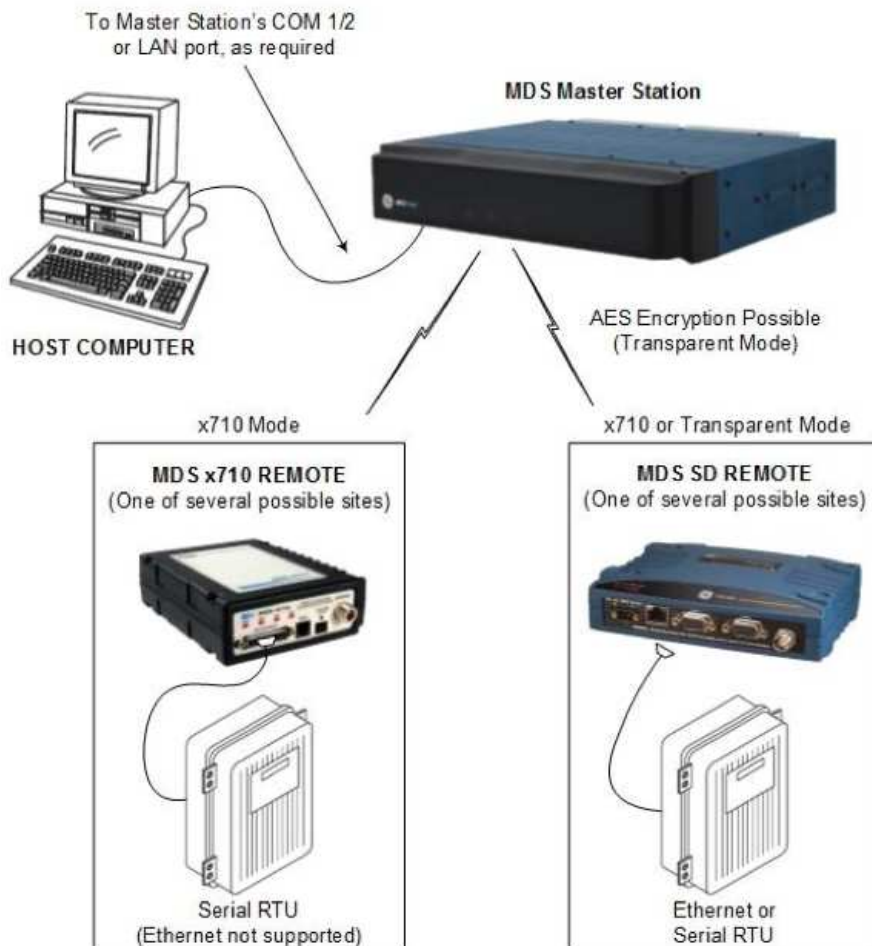

Figure 3-1 Application Example

3.1 Applications

The Master Station is designed for point-to-multipoint data transmission in utility SCADA communications, transactional systems, and telecommunications systems. The wireless network provides communications between a central host computer and remote terminal units (RTUs) or other data collection devices. In such an arrangement, the operation of the radio system is transparent to the computer equipment.

Repeater and Polling Remote Operation

In a system using FCC Part 90 repeater and polling remote, the polling remote radio operates in half-duplex mode and the repeater operates in full-duplex mode. The SD Master Station can be used as a polling remote, or as a repeater. Refer to Page 46 for details on configuring the radio for repeater operation.

Simplex and Switched Carrier Operation

System-wide simplex operation is achieved by switching the Master Station carrier on to transmit, and then off to receive. The same frequency is used for both transmit and receive.

Switched carrier, half-duplex mode works in the same way, except *different* frequencies are used for transmit and receive.

Refer to Page 60 for details on configuring the radio for simplex or switched carrier operation.

3.2 Network Management

Network-Wide Diagnostics

The Master Station offers network-wide diagnostics capability, sometimes referred to as DLINK Diagnostics. Network-wide diagnostics communications is a packetized diagnostic capability that provides the following advantages:

- You can gather diagnostic data over a large radio network without disrupting the system communications flow.
- When required, you can increase diagnostics communications speed by actively collecting diagnostic data.
- You can access diagnostic data for each radio in the network from any radio diagnostics port in the network.
- You can broadcast certain messages to all radios in the system simultaneously.

You can use the Master Station to poll remote radios in its radio system for diagnostic data. For more information on the implementation of network-wide diagnostics, refer to the GE MDS Network-wide Diagnostics Handbook (P/N 05-3467A01).

Network Management Using PulseNET

PulseNET uses the DLINK protocol to monitor the Master Station and downstream devices. The Master Station can be connected locally using either COM1 or COM2 serial or through Ethernet using TCP. Refer to the section “Dlink” on Page 50 for more information about configuring DLINK on the Master Station.



PulseNET remotely discovers and monitors Master Stations and other SD or x710 radios on the network using DLINK. The locally connected radio may be a Master, Repeater, Polling Remote, or Remote. This locally connected radio must be configured as the DLINK “root” radio. Downstream radios should be configured as “node”. PulseNET uses passive polling to discover the “root” radio and all of the “node” radios downstream. Passive polling allows monitoring without interrupting payload data transmission.

In order for PulseNET to discover Master Stations in the network, DLINK must be enabled and properly configured. Refer to the section “Dlink” on Page 50 for information on how to configure DLINK.

3.3 Redundant versus Non-redundant Operation

A redundant configuration means that the Master Station has two complete transceiver boards and power supplies installed in the enclosure. In the event of a failure in the primary equipment, the controlling logic switches to the stand-by unit. The stand-by transceiver board is constantly operating and its operational readiness is monitored. However, the power amplifier in the stand-by board is not operating when it is in stand-by mode.

In a non-redundant configuration, there is only one transceiver board installed in the enclosure, and back-up transceiver board operation is not possible.

Transceiver boards may be moved from one Master Station to another; however an additional transceiver board cannot be added to a non-redundant Master Station. Redundant or non-redundant operation is automatically detected by the platform manager, and the active transceiver is automatically selected. Installing or replacing a transceiver board causes the board to communicate briefly with the Platform Manager to establish which transceiver board will operate as the active board and which operates as the stand-by. For more information, refer to section 7.4 Replacing Modules on Page 93.

3.4 Antennas and Feedlines

Antennas

The Master Station may be used with a number of different antennas. The exact style and gain factor depend on the physical size and layout of your system. Antennas of this type are available from several manufacturers, including GE MDS. Contact your factory representative for details. Connection is made to the station via N coaxial connectors at the rear panel.

Feedlines

The selection of an antenna feedline is very important. Poor quality cable should be avoided, as it will result in power losses that may reduce the range and reliability of the radio system.

The tables that follow show the approximate losses that will occur when using various lengths and types of coaxial cable in the 200, 400 and 900 MHz bands, respectively. Regardless of the type used, the cable should be kept as short as possible to minimize signal loss.

Table 3-1. Signal Loss in Coaxial Cables (at 900 MHz)

Cable Type	10 Feet (3 Meters)	50 Feet (15 Meters)	100 Feet (30.5 Me- ters)	200 Feet (61 Meters)
RG-8A/U	0.85 dB	4.27 dB	8.54 dB	17.08 dB
1/2 inch HELIAX	0.23 dB	1.15 dB	2.29 dB	4.58 dB
7/8 inch HELIAX	0.13 dB	0.64 dB	1.28 dB	2.56 dB
1-1/4 inch HELIAX	0.10 dB	0.48 dB	0.95 dB	1.90 dB
1-5/8 inch HELIAX	0.08 dB	0.40 dB	0.80 dB	1.60 dB

Table 3-2. Signal Loss in Coaxial Cables (at 400 MHz)

Cable Type	10 Feet (3 Meters)	50 Feet (15 Me- ters)	100 Feet (30.5 Me- ters)	200 Feet (61 Meters)
RG-8A/U	0.51 dB	2.53 dB	5.07 dB	10.14 dB
1/2 inch HELIAX	0.12 dB	0.76 dB	1.51 dB	3.02 dB
7/8 inch HELIAX	0.08 dB	0.42 dB	0.83 dB	1.66 dB
1-1/4 inch HELIAX	0.06 dB	0.31 dB	0.62 dB	1.24 dB
1-5/8 inch HELIAX	0.05 dB	0.26 dB	0.52 dB	1.04 dB

3.5 Grounding Considerations

To minimize the chance of damage to the radio and connected equipment, a safety ground (NEC Class 2 compliant) is recommended which bonds the Master Station, antenna system, and connected data equipment to a *single-point* ground, keeping all ground leads as short as possible.

The Master Station should be grounded using the #6-32 screw and star washer provided for this purpose on the rear panel.

The use of a lightning protector is also recommended where the antenna cable enters the equipment building; bond the protector to the tower/mast ground, if applicable. All grounds and cabling must comply with applicable codes and regulations.



Figure 3-2. Rear Panel Grounding Screw

3.6 Data Interface Connections

Ethernet Data Interface (RJ-45)

The Ethernet interface supports both radio management and payload data transport functions. For radio management, connecting via a web browser provides enhanced functionality and ease-of-use over serial/USB methods. Web-based management is the preferred and primary means of accessing the transceiver through the built-in *Device Manager*.

SSH may also be used on this connector, and provides the same CLI based user interface available via the serial/USB interfaces.

See section “Ethernet Interfaces” on Page 81 for electrical information and connector pinout.

Serial Data Interfaces

COM1 and COM2 provided on the front of the Platform Manager module serve as the serial interface ports for payload data, radio management, or diagnostics. Management is also available through the mini USB port. The default factory settings for the radio’s COM1 port is as a serial data port to connect to an external DTE serial device. The default factory settings for the radio’s COM2 port configure it for management of the radio via a serial connection to a PC. These ports are user-configurable for specific applications. The procedures for changing their default operation are provided later in this guide.



Not all PCs have a serial port. If one is not available, a USB-to-Serial adapter and appropriate driver software may be used to provide serial connectivity. These adapters are available from several manufacturers, including GE MDS.

Serial Data Connection

When used as a data port for an SD Radio Module in Transparent or x710 modes, some pins on COM1 and COM2 have special behavior determined by configuration. DCD (Data Carrier Detect) is asserted when the radio received an on-frequency signal. RTS (Request-to-Send) can be configured to key the transmitter when asserted. CTS (Clear-to-Send) can be configured to go “high” after the programmed CTS delay time has elapsed (DCE), or can be configured to key another connected radio when RF data arrives (CTS KEY

The included Com Port Adapter Cable 73-2434A25 can be used to convert the unit’s RJ-45 serial jack to a DB-9F type connector.

Table 3-3. RF-45 to DB-9F Pin Out

Signal	RJ-45	DB-9F	Standard RS-232
DSR	1	6	DSR
DCD	2	1	DCD
DTR	3	4	DTR
Ground	4	5	Ground
RXD	5	2	RXD
TXD	6	3	TXD
CTS	7	8	CTS
RTS	8	7	RTS
No connection	N.C.	9	RI

Mini USB

The Mini USB port can be used to management the radio through a scriptable command line interface (CLI) using the proper USB drivers available at www.gemds.com. Connect to the management PC using the included Mini USB Cable. Once the PC registers the device driver, the port will auto baud. The USB port provides CLI management only and cannot be used for network diagnostics or for payload data.

Alarm Output and 4-Wire Audio

Alarm and audio signals are provided on the Alarm or Alarm/Relay module. Refer to Table 6-15 for details on pinout and signal descriptions. Audio signaling and alarm outputs are software configurable. Refer to Section 5.0 Device Management for more information.



4.0 INSTALLATION PROCEDURES

This section presents the steps necessary for installing the radio and connecting it to associated equipment. After completing these steps, the radio is ready for in-service operation.

4.1 Unpacking and Inspection

Check the contents against the packing list secured to the outside of the shipping box. Accessories and spare parts kits, if any, are wrapped separately. Inspect all items for signs of damage. Save all packing materials in case you need to ship the radio in the future.

4.2 Installation Steps

The radio should be installed in a relatively clean, dust-free environment that allows easy access to the connectors and indicators. Air must pass freely over the rear heat sink and around the unit for proper cooling. Follow the steps below to install the unit and prepare it for initial startup.

⚠ CAUTION

The rear heat-sink will get hot under continuous or high duty-cycle transmission. Use caution handling the unit while in operation.

1. **Mount the Unit.** The unit may be rack-mounted (2U high) in a 19-inch rack cabinet, or may be placed on any sturdy tabletop or other flat surface. The installation site should be free of excessive dust, and should have adequate ventilation. The chassis should be positioned so that all interface cabling will reach the required connectors.
 - a. When rack mounting, the rack ears can be installed in one of three positions to allow flexibility in the mounted depth of the chassis. The unit should be mounted so as to maximize airflow around the rear heat sink.
2. **Ground the Chassis.** Use the ground screw provided at the rear panel to connect the radio to a safety ground (NEC Class 2 compliant), which bonds the Master Station, antenna system, and connected data equipment to a *single-point* ground. Keep all ground leads as short as possible.



3. **Connect Antenna Feedlines.** All coaxial antenna connections are made to the Type-N connectors on the rear of the unit. The number of connections depends on options ordered, including duplexer options, as follows: Separate TX and RX; Combined TX/RX; wired for an external notch filter with RX Out, RX In and combined TX/RX.

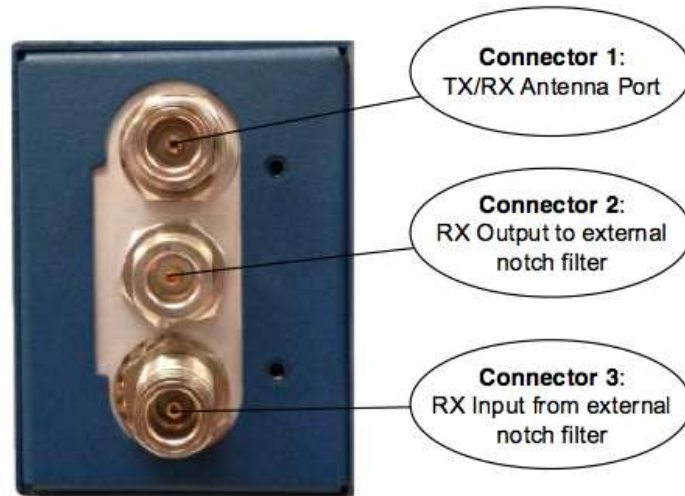

Figure 4-1. Internal Duplexer, Triple N connectors

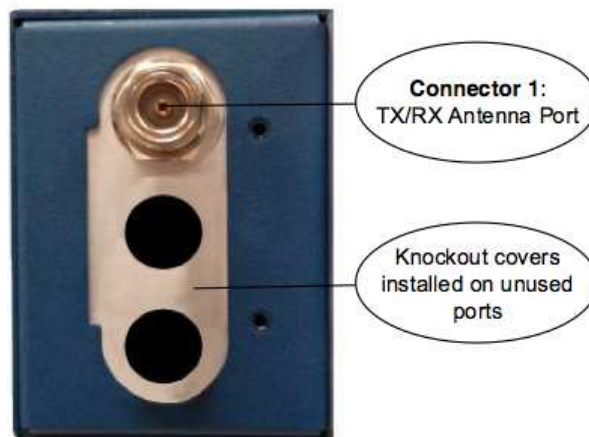

Figure 4-2. Internal Duplexer (or internal T/R switch), Single N connectors

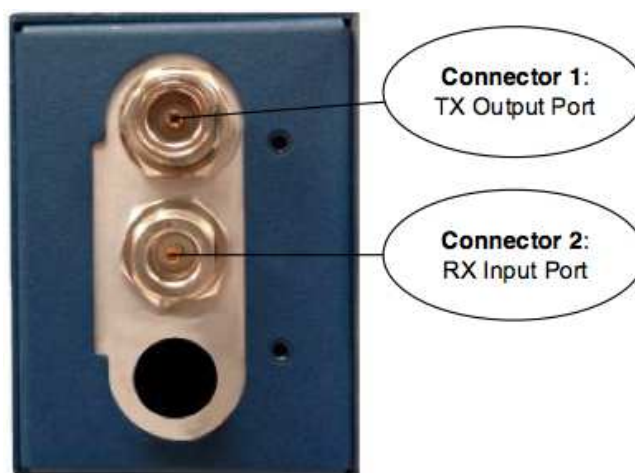

Figure 4-3 External duplexer or dual antennas
(TX and RX ports pass directly through)



4. **Install the Data Interface Cabling.** Interface connections are made to the front of the Platform Manager module. Typical connections for most sites include:
 - **Serial Data**—Attach data equipment to the front panel COM1 and/or COM2 ports. The unit is hardwired as a DCE device (DB9-F to RJ-45 connector, GE MDS part no. 73-2434A12).
 - **Ethernet LAN**—Attach data equipment to the ETH1 and/or ETH2 port. The auto-sensing MDIX feature allows either a straight-through or crossover cable to be used.

Where applicable in the steps that follow, secure all cable connections with the locking screws provided.

5. **Connect Primary Power**—The Master Station is powered using one or two power supply modules that work in tandem. The modules may be AC, DC, or a combination of both. The following tables list each type and key operating parameters.

Table 4-1. AC Power Supply Module

Module	Input Power	Current Rating
6755	100-220 VAC, 50/60 Hz	120W Max.

All DC power supply modules have chassis isolated inputs and a diode bridge for floating ground, positive ground, or negative ground installations. These modules include a keyed power connector with screw-terminals. Strip the wire leads to 6mm (1/4 inch) and insert them into the wire ports provided. Be sure to observe the polarity shown below. Tighten the binding screws securely and insert the connector into the module. For compliance with CSA, torque thumbscrews to 10in-lbs.

Table 4-2. DC Power Supply Modules

Module	Input Power	Current Rating
6843	+/- 12-36 VDC	10 A Max.
6844	+/- 36-75 VDC	3.5 A Max.
6845	+/- 75-140 VDC	2 A Max.

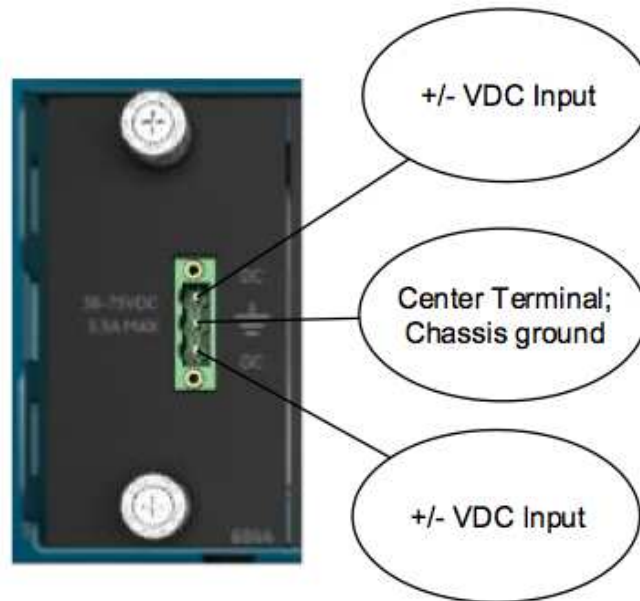

Figure 4-4 DC Power Connector

6. Connect a PC for Configuration (LAN or USB port). This prepares the Master Station for programming of desired operating parameters. Configuration is further described in **Section 5.0 Device Management**



If serial-based cabling is used for configuration, an adapter may be required at the PC, as many PCs do not offer a serial port. In such cases, a USB-to-Serial adapter (with appropriate driver software) may be used. These adapters are available from a number of manufacturers.

7. **Radio, Alarm/Relay, and Duplexer Connections**—The Alarm/Relay module provides two alarm outputs, one for major and one for minor alarms. This module also provides TX/RX audio, PTT (TX keying), and analog RSSI connections. See “Alarm/Audio Interface” on Page 88 for pinout connections.

All other required connections on the front of the unit are cabled at the factory per ordered options.

8. Add connection of battery backup, as applicable.

Initial Startup & Operation

The radio is designed for continuous, unattended operation, but does require some minimal provisioning before operation. This section explains the use of the radio’s indicators and provides steps for initial startup of the equipment. Once a unit is provisioned, operator intervention is not required, except to power the unit up or down, or to change an operating parameter. Operation of the radio can be started by simply connecting primary power to the unit.

Module LED Indicators

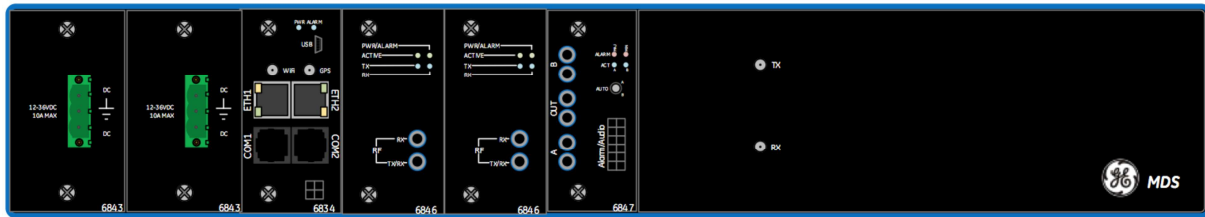

All LED indicators are on the front of the unit. Platform Manager, Radio, and Alarm Modules include LEDs. A redundant unit will be populated as shown above. A non-redundant unit will have only one Radio Module and a different Alarm Module without RF connections.

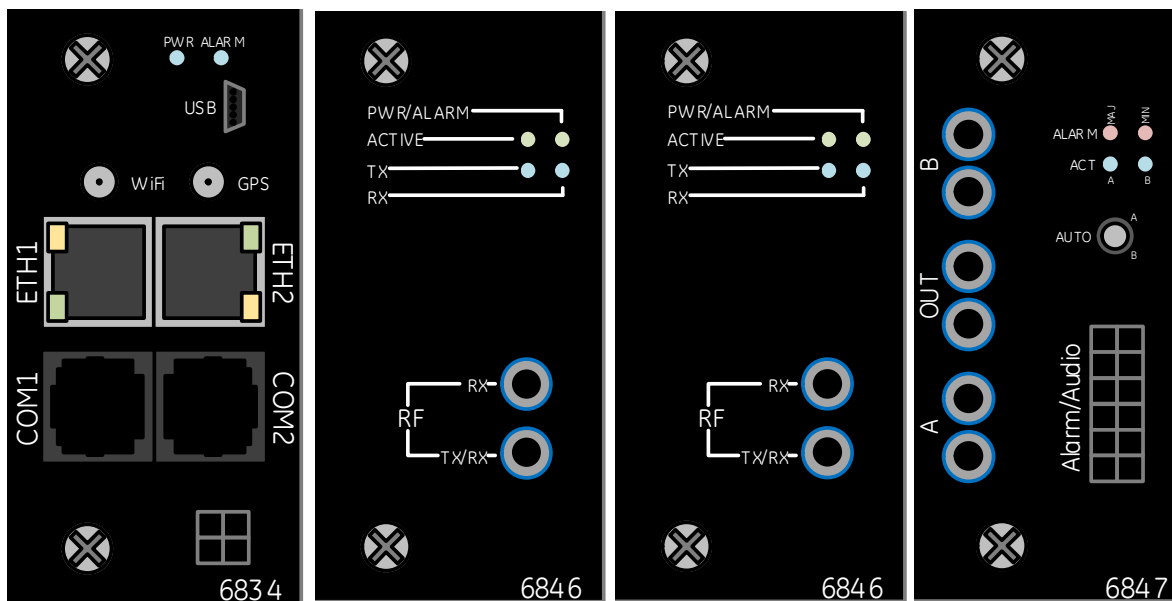

Figure 4-5 LED Indicators

Normal Indications

When power is first applied, the following events occur in a normally working unit:

- All front panel indicators light briefly
- The **ACTIVE LED** for the selected transceiver board lights.
- The **Power LED** on the transceiver modules will begin to flash indicating they have not yet communicated with the platform manager.
- The **Power LED** and **Alarm LED** will light on the Platform Manager card. At this point the platform manager is performing a pre-boot validation of the firmware to ensure that all required security signatures are in place and valid.
- The **Alarm LED** will turn off and the **Power LED** will begin to flash. At this point the platform manager is booting and initializing the system.
- Once the platform manager initializes the transceiver module, the **Power LED** will stop flashing and turn solid.

Maximizing RSSI

Since the Master Station almost always uses an omni-directional antenna, maximizing signal strength is done at the remote sites where directional antennas are typically used. An RSSI stronger than -90 dBm is desirable. Refer to Section 5.0 Device Management for information on monitoring the RSSI for the Radio Module.



5.0 DEVICE MANAGEMENT

This section describes the steps for connecting a PC, logging in, and setting unit parameters. The focus here is on the local serial/USB console interface, but other methods of connection are available and offer similar capabilities. The key differences are with initial access and appearance of data.

The MDS™ Master Station offers several interfaces to allow device configuration and monitoring of status and performance. These include local serial console, USB, NETCONF, HTTP/HTTPS, and Secure Shell (SSH) for local and remote access via the WAN and LAN networks. The serial console, USB, and SSH services offer a command line interface (CLI). There are three user accounts/roles for management access: **admin**, **tech**, and **oper**. User accounts can be centrally managed with a RADIUS server, with RADIUS accounts being mapped to one of the three user accounts/roles. Refer to **MDS Orbit MCR Technical Manual (05-6632A01)** for details on configuring RADIUS authentication.



The MDS™ Master Station is designed for high security environments. As such, management of the device does not support Telnet, but instead implements the more secure SSH protocol.

5.1 Pre-Configured Settings

The unit is highly configurable to meet field requirements, but comes pre-configured as follows:

- COM1 is configured for transparent serial payload at a baud rate of **115200, 8N1**.
- COM2 is configured to operate at a baud rate of **115200, 8N1** and is enabled for local console operation.
- USB is enabled for local console operation (proper system drivers must be installed on the PC connected to the MDS™ Master Station to use the USB port as a virtual serial device; these drivers are available from the GE MDS website).
- The Ethernet ports are bridged together, with spanning-tree protocol enabled, with a default IP address of **192.168.1.1/24**.

5.2 One-Time “Recovery” Passwords

The MDS Orbit platform employs extensive security measures to prevent unauthorized access. As such, there are no hidden manufacturer passwords or other “backdoors” found in less secure products.

If a password is lost, there is no way to access the unit, except by using a one-time password (OTP) for recovery. The user must create this OTP manually. Without a one-time password, the unit will not be accessible, and the hardware will need to be replaced. ***The factory will not be able to assist you if a password is lost, so creating a one-time password is strongly encouraged.***

One-Time Passwords: How They Work

One-time recovery passwords put control directly and exclusively in the user’s hands. They are similar to spare keys for a lock. If you make a spare key, and put it away safely, you can take it

out to quickly gain entry when your primary key is lost. If you don't make a spare, you are always at risk of locking yourself out.

A one-time recovery password is different from the one used to log into the unit on a routine basis. It is *only* for use when the primary password is lost or forgotten. When a one-time password is used to log in, that password is *automatically revoked* from the list of passwords created. (You may create up to five one-time passwords at one time, and more can be created if some get used). Once used, a password cannot be used again for log-in to the unit (hence the name “one-time” password)

Creating a One-Time Password

To create a one-time recovery password via the console, enter the following command, where <selected function> is either “factory-reset” or “login”

```
> request system recovery one-time-passwords create function selected function
```



A one-time password is automatically generated and displayed on the screen. Copy this password and save it in the desired location on your PC. *There is no way to ever view it again from the command line console, so be sure it is properly saved.*

To create additional one-time passwords (up to a total of five), repeat the step above.

Logging in With a One-Time Password

Logging in with a one-time password can only be performed from the local serial or USB console. Note the local serial *cannot* be used if configured as a payload or diagnostic interfaces. You also cannot use a one-time password when connecting to the unit remotely. Therefore, in some configurations, the USB console is the only option.

To use the one-time password for log-in, proceed as follows:

- At the **username** prompt, enter the word **recovery**.
- At the **password** prompt, paste in the one-time-password saved earlier on your PC. Using a one-time-password forces the unit to perform the “function” which was previously defined when the password was created:
- **factory-reset**—The unit resets its entire configuration to factory defaults
- **login**—The unit allows logging in with “admin” privileges

Special case: If someone has disabled console access on the USB port, the login prompt will still be present on that console, but only one-time-passwords will be accepted. This is done to provide a way to recover the unit in the case where the USB port has been disabled and the unit cannot be accessed via TCP (for example; SSH).

Deleting a One-Time Password

As noted earlier, a one-time password is automatically revoked when it is used for log-in. A revoked password may be replaced, but it must first be removed from the list so a new one can be generated. Any of the five stored passwords may be removed on demand. As long as there is a free slot, an additional password can be created, up to the maximum number of five. Logs are generated when the user creates, deletes, or logs in with a one-time-password. To remove an existing password from the list, proceed as follows:



Enter the command **request system recovery one-time-passwords delete identifier <X>**, where <X> is a number from the currently available one-time passwords. This identifier is not reused. If all five passwords have been created, then ID 1 can be deleted, and the next created password will be at ID 6.

The current list of passwords may be viewed by issuing the command **show system recovery one-time-passwords**. The following is an example output from that command. On the unit shown, only two passwords have been stored. Password 1 or 2 can be deleted from this list.

IDENTIFIER	FUNCTION	STATUS	DATE CREATED	DATE REVOKED	USER
1	login	usable	2012-06-19T00:27:24+00:00		
2	login	usable	2012-06-19T00:27:25+00:00		

5.3 Configuration via Command Line (CLI)

A scriptable command-line interface is accessible through the radio's Ethernet port using Secure Shell (SSH) terminal, or through the unit's USB interface. For enhanced security, the unit does *not* support Telnet configuration. The steps below describe a cabled USB connection and assume the proper drivers have been installed.

1. Install the USB virtual serial port driver, which is available on the GE MDS web site.
2. Connect a PC to the unit's USB port and establish a console terminal session using a serial communications program.
3. Press the **ENTER** key to receive the login prompt.
4. Enter the username (**admin** is the default username) and press **ENTER**.
5. At the Password prompt, enter the password (**admin** is the default password). Press **ENTER**. Upon successful login, the connection message appears.
6. Enter the configuration mode by typing **configure** followed by the **ENTER** key.
7. Review and configure all key settings for the required application. Built-in help is available by pressing the **Tab** key. A summary of all unit settings may be viewed by entering the **% show | details** command.

Tab Completion Feature

Tab-completion is a powerful feature that provides assistance when typing commands in CLI. Depending on the text that was already entered, tab-completion displays different possible completions. When the Tab key is pressed and no text has been entered, the CLI shows all possible commands that can be typed.

CLI Quick Reference Table

Table 5-1. CLI Quick Reference Table provides a summary listing of commonly needed tasks and the appropriate commands to enter. The table can be used as a quick reference before consulting the more detailed information, which follows in this section. Each CLI command is preceded by the symbol **>** for operational command, or **%** for a configuration command.

Table 5-1. CLI Quick Reference Table

If you wish to...	Enter this CLI command:
Create a one-time password	> request system recovery one-time-password create function <user function>
View all network interface status and statistics	> show interfaces-state interface
Create a bridge	% set interfaces interface <i>bridge</i> type bridge
Add the ETH1 interface to a bridge	% set interfaces interface <i>bridge</i> bridge-settings members port <i>eth-0/0/0</i>
Remove the ETH1 interface from a bridge	% delete interfaces interface <i>bridge</i> bridge-settings members port <i>eth-0/0/0</i>
View SDMS Settings	> show configuration interfaces interface <i>sdms</i> sd-config
Monitor SDMS Status (RSSI, SNR, etc)	> show interfaces-state interface <i>sdms</i> sd-status repeat 5
Configure SDMS Frequencies	% set interfaces interface <i>sdms</i> sd-config radio-config basic-config receive-frequency <value> and/or % set interfaces interface <i>sdms</i> sd-config radio-config basic-config transmit-frequency <value>
Configure SDMS Modem	% set interfaces interface <i>sdms</i> sd-config radio-config basic-config modem-type <modem>
Configure the SDMS Radio Mode	% set interfaces interface <i>sdms</i> sd-config radio-config basic-config radio-mode <radio mode>
Configure SDMS Radio Power	% set interfaces interface <i>sdms</i> sd-config radio-config basic-config rf-output-power <value>
Key/Dkey the SDMS Radio	> request interfaces interface <i>sdms</i> sd-config maintenance rf-key-test key radio true/false
Send a Remote Maintenance Request to Remotes	> request interfaces interface <i>sdms</i> sd-config maintenance remote-management-command <command name> <value>
View the routing table	> show routing
View the event log	> show table logging event-log
Set the admin user's password	> request system authentication change-password user <i>admin</i> password <i>admin1234</i>
Set the device name	% set system name "Mydevice"
Set the baud rate on COM1	% set services serial ports <i>COM1</i> baud-rate <i>b19200</i>
Download a firmware package from TFTP server at 192.168.1.10	> request system firmware reprogram-inactive-image filename <i>sdms-bkrc-1_0_0.mpk</i> manual-file-server { tftp { address <i>192.168.1.10</i> } }
Monitor firmware download status	> show system firmware reprogramming-status
Export configuration file to a TFTP server at 192.168.1.10	> request system configuration-files export filename <i>myConfig.xml</i> manual-file-server { tftp { address <i>192.168.1.10</i> } }
Reboot device to firmware inactive image	> request system power restart inactive

5.4 Interface Naming

Interface naming of physical devices on the MDS™ Master Station uses the following format:

<type>-<slot>/0/<port>

Where type is one of the following values:

Interface Type Abbreviations	
Type	Description
eth	Ethernet Interface
sd	SD Radio Module
wifi	WiFi Interface

Slot-0 is the slot identifier for the platform manager, while slots 1-3 map to the available interface slots in the chassis.

Ports are zero-based and map to the port number of the given interface type in the specified slot. Note that not all interface types have port values that are non-zero (e.g. An SD radio module only has one “port”, so it will always be ‘0’)

The center 0 value in the interface name is always 0, and is reserved for future use.

Examples of valid interface names are

- eth-0/0/0 – The first Ethernet port on the platform manager card in slot-0
- eth-0/0/1 – The second Ethernet port on the platform manager card in slot-0
- sd-2/0/0 – The SD Radio module in slot-2.

Logical (non-physical) interfaces such as bridges and VLANs use free-form names and can be renamed by the user.

5.5 Configuration via the Device Manager

The *Device Manager* is a built-in software tool that works with your PC’s browser to provide an intuitive, web-style presentation of all unit information, settings, and diagnostics. Device manager is accessible through ETH1 or ETH2 using a web browser.

Minimum browser requirements: IE10 or later, Chrome, Firefox, or Safari.



For security, web access can be enabled/disabled via the CLI using the command `% set services web http(s) enabled true/false`

General Configuration

For initial configuration of the Master Station, perform the following steps:

1. Connect the unit to a PC via an Ethernet connection.
2. Configure your PC network settings to an IP address on the same subnet as the unit. The default subnet mask is **255.255.255.0**.



For IP addressing the Master Station uses a routing prefix expressed in CIDR notation instead of specifying a subnet mask. The CIDR notation is the first address of a network, followed by a slash character (/), and ending with the bit-length (max 32) of the prefix. A subnet mask is expressed in dot-decimal notation. For example, **192.168.1.0/24** is equivalent to specifying **192.168.1.0** with a subnet mask of **255.255.255.0**.

3. Open a web browser and navigate to the IP address of the unit (default Ethernet IP address is **192.168.1.1**). The initial sign-in prompt appears.



The image shows a web-based sign-in form with a light blue background. At the top, it says "Sign in" in bold. Below that is the label "Username:" followed by a text input field containing the placeholder text "Username". Underneath is the label "Password:" followed by a text input field containing the placeholder text "Password". At the bottom of the form is a "Sign in" button.

4. Enter the username and password (admin is the default entry for both fields), then click 'Sign In'.
5. On first-time login, the Initial Setup Wizard will appear and provide guidance for general device setup. This is disabled after the initial setup has been complete but may be re-run at any time by accessing the Wizards link on the left side of the screen, and clicking Initial Setup.

Key items that should be reviewed and/or set for the radio include:

- Create one-time programmable passwords for unit recovery
- Change login passwords (to maintain security)
- Evaluate default factory configuration and lock the unit down to the required security level

When the Initial Setup wizard completes, select **Wizards → SD Setup**, which steps you through initial SD Radio Module configuration. Key items that should be reviewed and/or set include:

- Radio Mode
- Frequency plan
- Modem selection
- Keying mode
- Repeater Configuration (if necessary)
- Serial data interface configuration
- Encryption settings



5.6 Interface Configuration

Understanding

A serial cable (RJ45 cable with proper ETH to DB9 converter) may be used to connect to a COM port on the unit to access the CLI. The default serial console settings are 115200 bps with 8N1 format. A mini-USB-to-USB cable may also be used to connect to a Computer in case no serial port exists. If a mini-USB connection is used, the computer must contain the appropriate device driver. A driver for serial operation can be found on GE MDS website.

Configuring

The screen below shows console access to the COM1 serial and USB port:

Navigate to: *Services* → *Serial* → *Basic Config*

Ports

Search

Name	Line Mode	Baud Rate	Byte Format	Hw Flow Control	Hw Device Mode	Cts Delay
COM1	rs232	b115200	bf8n1	false	DCE	0
COM2	rs232	b115200	bf8n1	false	DCE	0
USB1	rs232	b115200	bf8n1	false	DCE	0

Showing 1 to 3 of 3

[Console](#)
[Terminal Server](#)

Clicking on the row of the port you wish to edit will present you with the following options:

Configure Ports Details

Line Mode:

Baud Rate:

Byte Format:

Hw Flow Control:

Vmin:

Vtime:

Capability: Modem Control

[Finish](#)

- Line Mode** - Selection of the operation line mode of the serial port. Choices are:
 - **RS232** (DEFAULT)
 - **RS485 - 2 Wire**
 - **RS485 - 4 Wire**
- Baud Rate** - The serial port baud rate in bps. Choices are 1200, 2400, 4800, 9600, 19200, 38400, 57600, 115200 (DEFAULT)
- Byte Format** - The data byte format in bits, parity and stop bits: Choices are:
 - **7N1** - 7 char bits, no parity, 1 stop bit
 - **7E1** - 7 char bits, even parity, 1 stop bit



- **7O1** - 7 char bits, odd parity, 1 stop bit
 - **7N2** - 7 char bits, no parity, 2 stop bits
 - **7E2** - 7 char bits, even parity, 2 stop bits
 - **7O2** - 7 char bits, odd parity, 2 stop bits
 - **8N1** - 8 char bits, no parity, 1 stop bit (DEFAULT)
 - **8E1** - 8 char bits, even parity, 1 stop bit
 - **8O1** - 8 char bits, odd parity, 1 stop bit
 - **8N2** - 8 char bits, no parity, 2 stop bits
 - **8E2** - 8 char bits, even parity, 2 stop bits
 - **8O2** - 8 char bits, odd parity, 2 stop bits
- **Hw Flow Control** - Hardware flow control enable/disable (DEFAULT) using RTS/CTS lines
 - **Vmin** - Receive Buffer Size - The minimum number of data bytes that will be buffered by the serial port before handling of the data to be processed by the terminal server. (255 = DEFAULT).
 - **Vtime** - Receive Inter-Byte Timeout - The amount of time between bytes of data on the serial port (**in multiples of 1 millisecond**), that indicate the end of a serial message ready to be processed by the terminal server. (100 = DEFAULT)



Vmin and **Vtime** setting only have an effect when the serial port is not being used as an SD payload or diagnostics (DLINK) port.

Serial Hardware Flow Control

When serial port is not being used as a SD payload or SD diagnostics (DLINK) port:

- **Hardware Flow Control:** When operating in CTSKEY mode, all serial ports in the data path are required to be set to the same baud rate, and that VMIN and VTIME remain at the defaults for serial data packets less than or equal to 255 bytes. For serial packets over 255 bytes it is recommended that a cts-delay time of at least 90ms be used to account for the VTIME delay of the over-the-air sending unit.

Hardware Flow Control Modes

When port is not being used as a SD payload or SD diagnostics (DLINK) port:

- **DCE**
 - CTS follows RTS after a programmable **CTS delay**.
 - If the unit's input buffer approaches a full condition it can deassert CTS regardless of state of RTS.
- **CTSKEY**
 - Based on legacy MDS devices including TransNET, the device will act similar to a DTE but will provide signaling on the CTS line instead of the RTS line.
 - When the first character of a transmission is ready to be sent to the serial port, the unit shall assert CTS and delay for **CTS delay time** expiration before outputting the first character.

- After the last character of a transmission is output from the serial port, the unit shall keep CTS asserted until the expiration of **CTS hold time**.

- **CTSKEYPLUS**

- The unit shall support flow control (Throttling) on the RTS pin. The device is expected to be wired via null modem to an external DCE device. The CTS line of the external DCE device drives the RTS line of the unit.



Statistics for the Serial ports and IP Payload 1, 2, 3 are located under the active SD radio interface (**Interfaces** → **sd-x/0/0** → **Status** → **Statistics**). See the section entitled “SD-x/0/0 Interfaces” for more details.

5.7 LAN

Understanding



This section will cover only the basic configuration of Ethernet ports and bridges. For full details on the configuration of more advanced features, please reference the **MDS Orbit MCR Technical Manual (05-6632A01)**

The Master Station has external Local Area Network (LAN) ports (ETH1/2 ports) that can be used to connect to a local (wired) LAN. It supports both IPv4 and IPv6 addresses and may be assigned multiple IP addresses. The LAN port can be assigned static IP addresses or a dynamically allocated address can be assigned using DHCP.



The LAN port should be assigned IP addresses only if it is a routed interface (that is, *not* in a bridge).

Configuring

To configure the LAN interface, select the eth-0/0/0 or eth-0/0/1. As shown in the screens below, there are five groups of configuration settings that can be configured: General ETHx specifics, IPV4, QOS, Filter, and NAT

Basic Config

Interfaces → **eth-0/0/x** → **Basic Config**

eth-0/0/0 Interface ↻

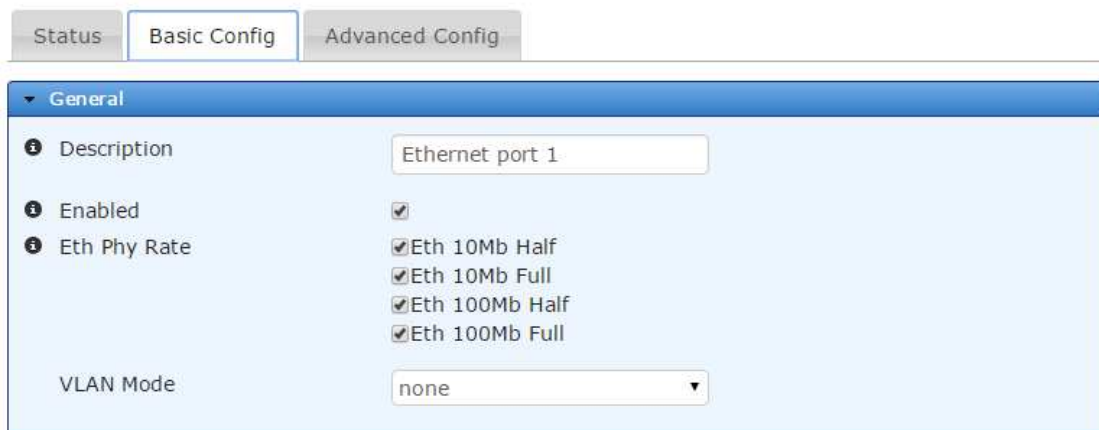

Tab	Status	Basic Config	Advanced Config
General			
Description	Ethernet port 1		
Enabled	<input checked="" type="checkbox"/>		
Eth Phy Rate	<input checked="" type="checkbox"/> Eth 10Mb Half <input checked="" type="checkbox"/> Eth 10Mb Full <input checked="" type="checkbox"/> Eth 100Mb Half <input checked="" type="checkbox"/> Eth 100Mb Full		
VLAN Mode	none		



Figure 5-1. ETH1 Configuration Screen

- **Description** - User defined identifier for this connection - 0-34 characters
- **Type** - Identifier of the type of interface - Do Not Change
- **Enabled** - Checked indicates Enabled (DEFAULT). Disable will prevent usage.
- **Eth Phy Rate** - Choose the Ethernet speed support setting (DEFAULT ALL)
 - Eth 10Mb Half
 - Eth 10Mb Full
 - Eth 100Mb Half
 - Eth 100Mb Full
- **Vlan Mode** - Virtual LAN Setting.
 - **None** (DEFAULT)
 - **Access** - Use this if this interface is intended to be a member of only a single VLAN.
 - **Trunk** - Use this if this interface is intended to be a member of multiple VLANs.

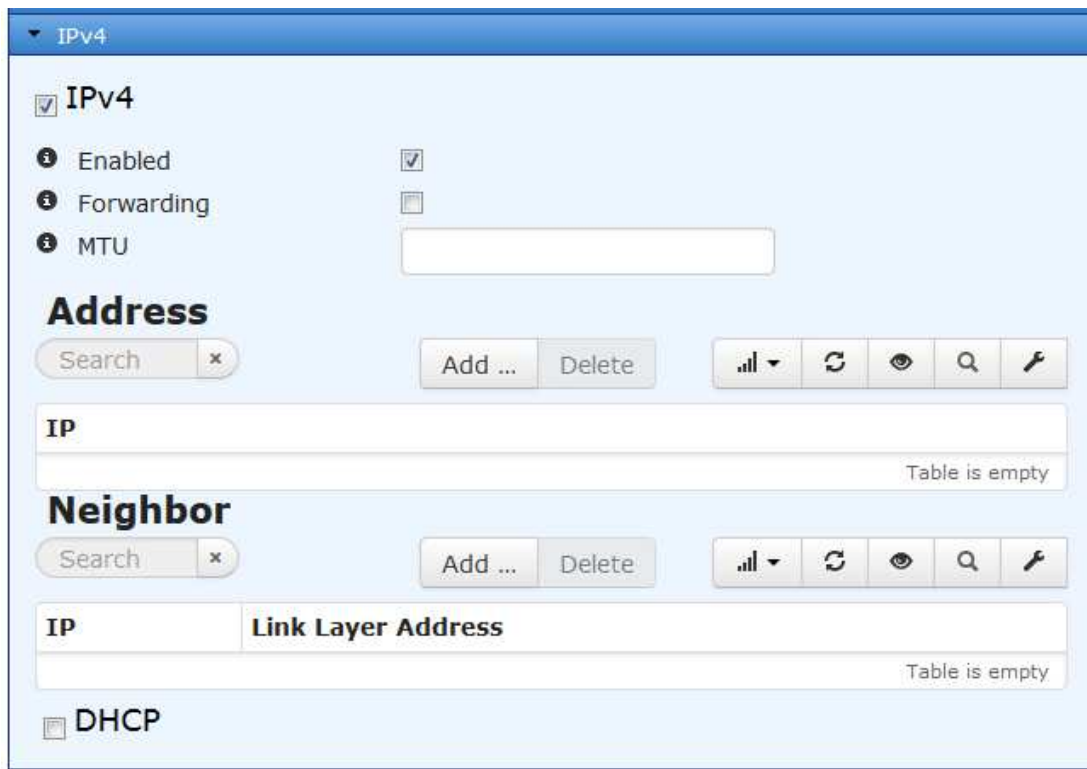

- **Enabled** - Enable or disable the use of an IP address
- **Forwarding** - Indicates if IPv4 packet forwarding is enabled or disabled on this interface. **True** (DEFAULT) / **False**
- **Mtu** - The size, in octets, of the largest IPv4 packet that the interface will send and receive. Range 68-65535 - 1500 (DEFAULT). (Advanced setting)

- **Address** - Use for creating static IPv4 IP address and removing this interface from the built-in Network Bridge.
- **Neighbor**- Use for creating mappings from IPv4 addresses to link-layer addresses.

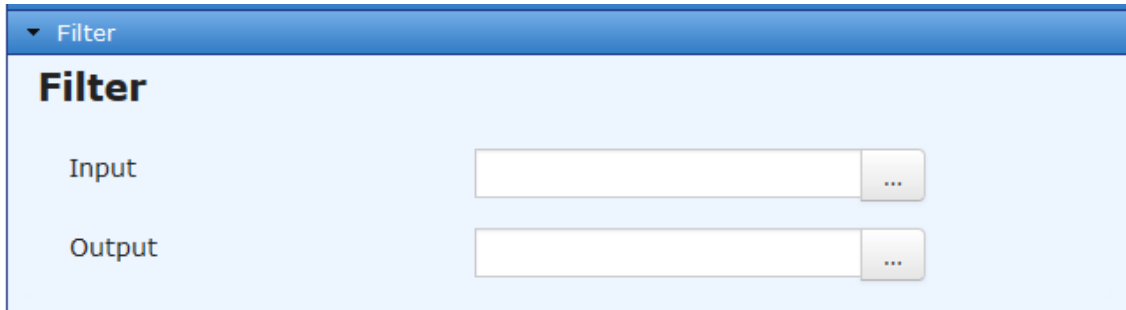

- **Filter Input** - Use for selecting and applying a firewall filter (from available filters) to incoming traffic on this interface.
- **Filter Output** - Use for selecting and applying a firewall filter (from available filters) to outgoing traffic on this interface.

For more information on packet filtering, refer to “Access Control List (Packet Filtering / Firewall)” in the **MDS Orbit MCR Technical Manual (05-6632A01)**

- **Input** - Default Selections (others may have been added) :
 - IN_TRUSTED
 - IN_UNTRUSTED
 - OUT_TRUSTED
 - OUT_UNTRUSTED
- **Output** - Default Selections (others may have been added) :
 - IN_TRUSTED
 - IN_UNTRUSTED
 - OUT_TRUSTED
 - OUT_UNTRUSTED

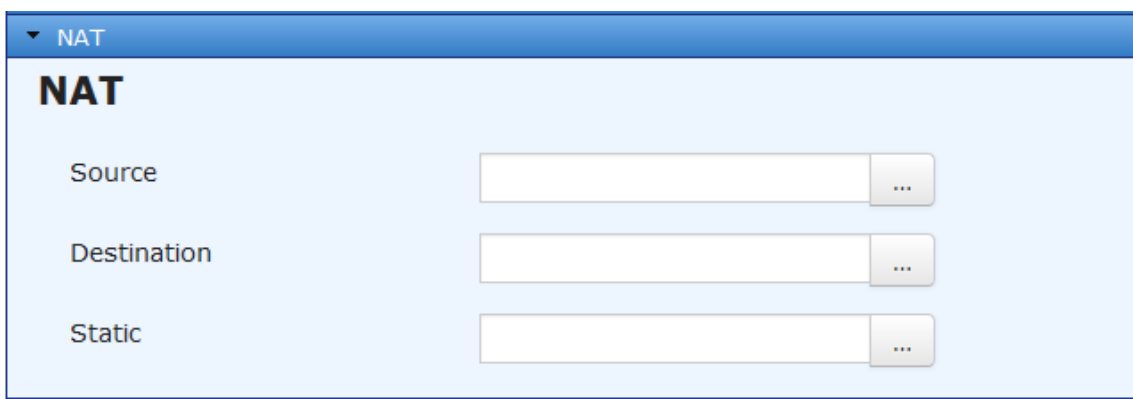

See the **MDS Orbit MCR Technical Manual (05-6632A01)** for information on configuring NAT.

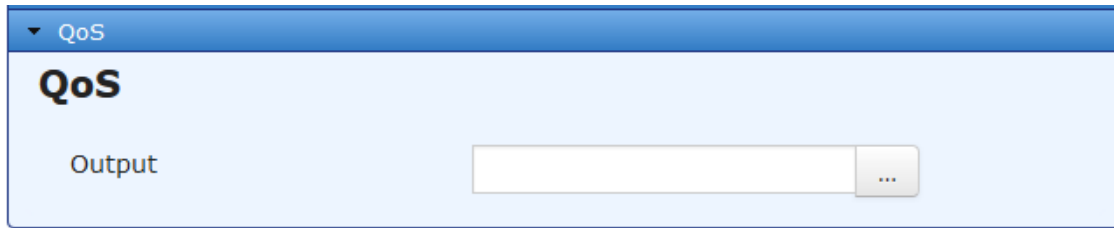

- **Output** - Use for selecting and applying a QoS policy (from the available QoS policies) to the outgoing traffic on this interface. See "Quality of Service (QoS)" in the **MDS Orbit MCR Technical Manual (05-6632A01)** for more information on creating QoS policies.

5.8 Bridging

Understanding

The unit supports transparent bridging of LAN, and in firmware versions of 3.0.0 and higher, WiFi and SD networks. The bridge forwards traffic between LAN interfaces and wireless interfaces at the layer-2 of OSI model. This allows LAN and wireless clients to be in the same IP sub-network.

The bridge learns the clients' locations by analyzing the source address of incoming frames from all attached networks. For example, if a bridge sees a frame arrive on LAN port from Host A, the bridge concludes that Host A can be reached through the segment connected to LAN port.

Through this process, the bridge builds a forwarding table (the learning process). When a frame is received on one of the bridge's interfaces, the bridge looks up the frame's destination address in its forwarding table. If the table contains an association between the destination address and any of the bridge's ports aside from the one on which the frame was received, the frame is forwarded out the indicated port. If no association is found, the frame is flooded to all ports except the inbound port. Broadcasts and multicast also are flooded in this way.

The bridged network is addressable via the 'bridge' interface (a virtual interface). The interfaces that are in the bridge are called bridged interfaces. The interfaces that are not in the bridge are called routed interfaces. Bridging is performed between bridged interfaces. Routing is performed between routed interfaces. The bridge interface itself is a routed interface.



In firmware versions less than 3.0.0, the SD interface is not a bridgeable interface as there is no packet or packet-with-MAC mode support in these versions of firmware.

Configuring

For full details on configuring bridge interfaces, please see the **MDS Orbit MCR Technical Manual (05-6632A01)**.

5.9 SDMS Interface

Understanding

The configuring of SD interfaces on the Master Station is performed through a virtual interface called 'sdms' (SD Master Station). This virtual interface, much like a bridge interface, is comprised of one or more sd-nic member physical interfaces. Each installed SDM Radio Module contains a single sd-nic. All configurations applied to the virtual SDMS interface will be propa-

gated to all member sd-nic interfaces. This insures that all SD radio interfaces in the system are using identical configurations so that interface fail-over is seamless.

To access the full suite of SD configuration options, select the sdms interface from the interfaces drawer on the left-hand menu.

Understanding the use of Virtual Radio Channels (VRCs)

VRCs allow over-the-air data to be directed to specific interface ports (IP or Serial) on the radio. Conceptually, this can be pictured as creating “pipes” for delivery of data to the desired radio interfaces.

VRC works by associating data from a specific port (IP and Serial) with a VRC channel number (1, 2, or 3). Each port at the receiving end then filters incoming data based on the associated VRC number.



The Virtual Radio Channel (VRC) feature is only supported in Packet w/MAC modes. It is not supported in Transparent or x710 mode.

To create the “pipes” that direct data to the desired ports, a route must be established using the IP Payload Configuration Menu (or payload serial settings on the general configuration menu for serial data). The default setting is to listen to *all* channels.) The Talk on parameter is used to specify the VRC used for sending the data stream over the air, while the Listen to parameter specifies the VRC(s) for incoming data.

Any combination of the three VRC numbers may be entered in the selection fields. Figure 5-2. Virtual Radio Channel (VRC) Concept illustrates the relationship between the VRC settings and the routing of data between units.

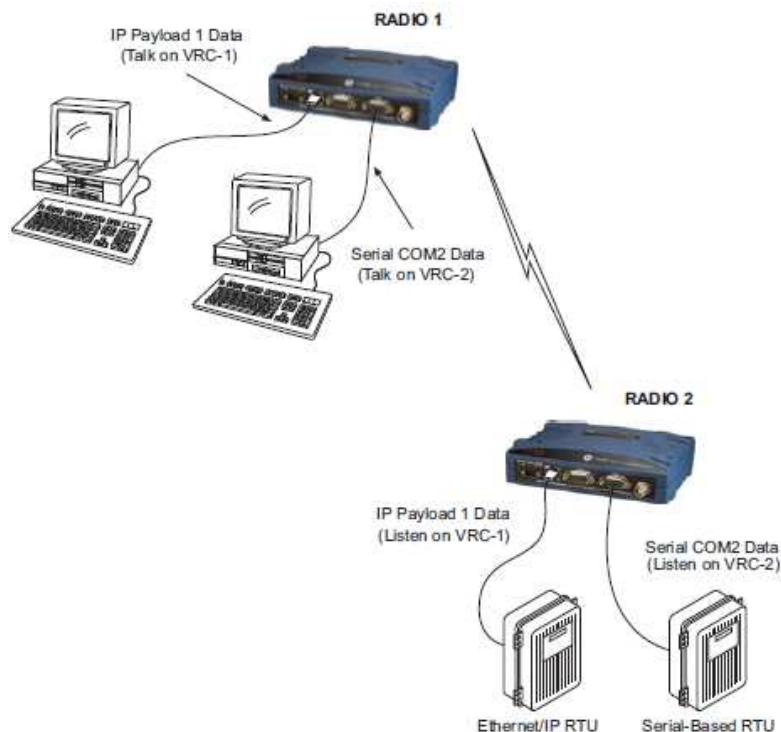

Figure 5-2. Virtual Radio Channel (VRC) Concept



Understanding the use of Media Access Control (MAC)

An important feature of the transceiver is Media Access Control (MAC). The radio's MAC is specifically designed for use with narrow bandwidth, half duplex radio networks such as those commonly used in licensed telemetry systems. When the MAC is enabled, it provides efficient support of multiple data traffic models including multiple hosts, synchronous and asynchronous polls, and report-by-exception (push traffic). MAC ensures that every transceiver in the network has an equal probability of gaining access to the radio channel when it has data to send.

Coordination of Channel Access

The main objective of the MAC is to coordinate channel access for all radios in the network, preventing data "collisions" that can occur with simultaneous transmissions from radios on the same RF channel. With MAC operation, a single radio is configured as an Access Point (AP) and other units are designated as Remotes. The AP serves as the controller of the RF network. Remotes request permission from the AP to use the RF channel before sending payload data, thus avoiding collisions of data, and creating a highly reliable wireless network. The MAC is responsible for allocating which unit gets access to the broadcast medium (the RF channel), when, and for how long.

Data Validation

Additionally, the MAC validates all messages and purges corrupted data from the system. Successful delivery of data is ensured through the use of retries and acknowledgements. Minimal overhead is used to accomplish these tasks, which translates to increased bandwidth efficiency of the radio channel with minimal latency, ensuring that messages are delivered in a timely manner.

Status Tab

The Status tab on the sdms interface page gives an overview of the current state of the sdms interface. The information displayed is described below:

General

Status Basic Config Advanced Config Actions

▼ General

i	Type*	sdms	Refresh every <input type="text" value=""/> seconds
i	Admin Status*	up	
i	Oper Status*	up	
i	IF Index*	6	
i	Relay Switch Position	Automatic	
i	Active NIC	sd-1/0/0	
i	Measured RF Power	0 dBm	
i	Signal to Noise	0 dB	
i	RSSI	-120 dBm	

Chassis Slot	State	Board Temperature	PA Temperature
1	Ready	● + 23 C	● + 25 C
2	Ready	● + 25 C	● + 29 C

Showing 1 to 2 of 2

This section shows a general overview of the SDMS interface. The current status of the relay switch, as well as which SD NIC is currently active is displayed here.

The **NIC Status** table is composed of the following columns:

- **Chassis Slot** – The slot in which the SD NIC was discovered.
- **Board Temperature** – The current temperature in degrees C as measured on the surface of the SD NIC. The colored indicator will transition to yellow and red as the NIC approaches it's operational limits.
- **PA Temperature** – The current temperature in degrees C of the power amplifier on the SD NIC. The colored indicator will transition to yellow and red as the NIC approaches it's operational limits.

Configuration

From the sdms interface page, all SD related configuration options can be specified. Primary SD network configuration can be found under the 'Basic Config' tab, more advanced options can be found under the "Advanced Config" tab, and operational actions can be found under the "Actions" tab.



Basic Config Tab

General

The Basic Settings contains important RF and modem selections for radio operation.

Setting	Value
Description	SD Master Station virtual interface
Members	sd-1/0/0, sd-2/0/0, Add an entry ...
Radio Mode	packet-with-mac
Modem Type*	38400n
RF Output Power	30
Transmit Frequency*	941.30625
Receive Frequency*	932.30625
Keying Mode	data
System ID	none
Repeater Mode	none
Allowed Ethernet Packet Types	unicast-and-arp
Serial Payload Port	disabled
Payload Buffer	<input checked="" type="checkbox"/>
Payload Serial Talk VRC	vrc-1
Payload Serial Listen VRC	all
Payload Serial 2 Port	disabled
Compression	<input type="checkbox"/>
Encryption	<input checked="" type="checkbox"/>
Payload Encryption Phrase

- **Members** – The Master Station (sdms) interface is a logical interface that is composed of one or more physical SD interface cards (sd-nic). The ‘members’ configuration item is the mapping between the logical sdms interface, and the physical sd-nic cards. A single sd-nic resides in each SDM Radio Module.

This is factory configured to contain SDM Radio Modules in slot 1 and slot 2 of the Master Station. If the Master Station is a non-redundant system with only 1 Radio Module, this will contain only 'sd-1/0/0'.

- **Radio Mode** – The radio can operate in one of several modes. The available selections are:
 - **Packet with MAC** – With and without AES Encryption
 - **x710** – When using the Master Station in a legacy x710 network.
 - **Transparent** – With and without AES Encryption. (Transparent w/AES Encryption requires an all SD radio network.)
- **Modem Type** – This setting determines the over-the-air data speed and bandwidth of the radio's transmitted signal. All radios in the network must use the same modem setting to communicate with each other. The default setting is Modem 9600, but it may be set to any of the selections shown in Table 5-2. Modem Selection vs. Speed, Bandwidth & Sensitivity. The table also lists modem sensitivity ratings for the various modems. Note that some modem choices are limited based on the model purchased.
- **RF Output Power (dBm)** – The RF output power may be set between 30 and 40 dBm (1 to 10 watts) in 1 dBm increments. The default setting is 40dBm. This setting represents the output power at the Radio Module. Output power at the antenna port on the back of the unit will be roughly 2dB to 3dB less depending on configuration. This is due to cable, switching, and duplexer losses. Full power is not required in many cases, and lower settings will place less demand on the power supply and reduce the chance of interference with other stations. Only the power necessary to carry out reliable communications should be used.
- **Transmit/Receive Frequency** – The receive and transmit frequencies may be viewed or set here. Frequencies must be entered for the radio to operate. Consult your station license to determine the authorized frequencies for your system, and enter them exactly as listed.
- **Keying Mode** – Keying mode must be set to one of the following values:
 - **Data** – Radio will key upon receipt of payload data.
 - **RTS** – Radio will key upon receipt of an RTS (request to send) signal on the serial port.

 **NOTE** RTS keying mode is only supported when the radio is in x710 mode.

 - **Data or RTS** – Radio will key upon receipt of either payload data or an RTS (request to send) signal on the serial port.
 - **Continuous** – Radio will be continuously keyed. This is primarily used in a transparent streaming repeater configuration.

 **NOTE** Continuous keying mode is only supported in x710 mode, or in transparent mode when operating as a repeater.

- **System ID** – Provides the possibility for Frequency Re-use. System ID offers nine unique choices including the default value of NONE. The setting NONE is required for mixed networks comprised of MDS legacy and SD products. SD-only networks can utilize the Frequency Re-use feature by setting the System ID to a common value [1-8] for all radios in a specific network. System ID offers approximately 20 dB of additional co-channel

isolation when operating networks on the same frequency. Note that proper system design is required.

Operational Example: SD System “Alpha” has eight units and SD System “Beta” has eight units. A user wishes to occupy frequency 952.1235 MHz on both of these systems. Proper system installation has been adhered to in both networks. System Alpha’s units would all be set to System ID = 1, System Beta’s units would be set to System ID = 5. Both systems will now operate on the same desired frequency.

Examples of valid and invalid arrangements are shown in Figure 5-3 and Figure 5-4, respectively.

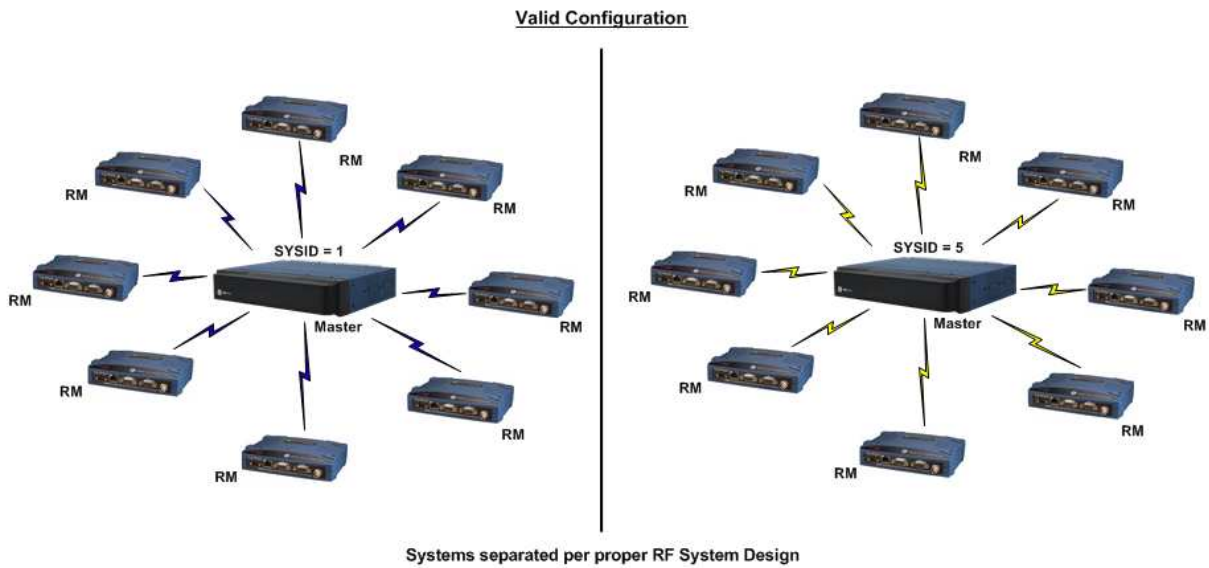

Figure 5-3. System ID Example — Valid Arrangement

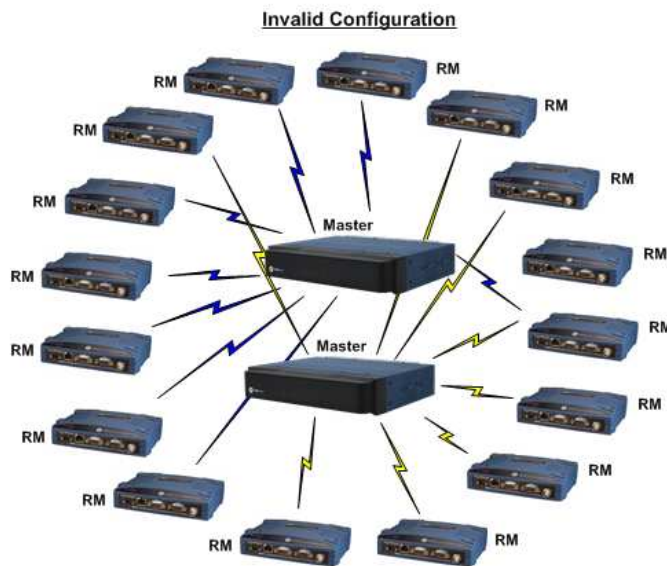

Figure 5-4. System ID Example — Invalid Arrangement

- **FCC Part 90 Repeater Mode** – Repeater mode must be set to one of the following values:
 - **None** – This is the default value, and is used when the Master Station being configured is not to be used as a repeater in the network.
 - **Repeater** – This value should be selected when the Master Station being configured is to be installed as a repeater in the network, and will not have devices connected to it that will be polled, such as attached RTUs.
 - **Repeater With Local Data** – This is the same as “Repeater” but should be used when data-collection devices such as serial RTUs will be attached directly to the repeating Master Station.
- **Allowed Ethernet Packet Types** – When operating in packet-with-mac mode, and sending Ethernet traffic, this option will restrict the types of Ethernet frames that will be sent over the air. Options are:
 - **None** – This will prevent any Ethernet frames from being transmitted over the air.
 - **All** – All Ethernet frames will be sent over the air, regardless of type.
 - **Unicast Only** – Only unicast packets will be sent over the air.
 - **Unicast and ARP** – This is the default value and will only allow unicast frames, or broadcast ARPs to be transmitted over the air.
- **Serial Payload Port** – The front-panel serial port that will be used for serial payload communications. This can be set to COM1, COM2, or disabled if the system will not be used for transmitting serial data. The default value for this is COM1.



Serial port settings such as baud rate and byte format are located under **Services** → **Serial** → **Ports**.

- **Payload Buffer** – The transceiver’s buffer provides a way of handling data 'over-runs', where more data is passing through the COM port than can be immediately handled by the unit. When the payload-buffer is on, any such data is stored up and processed in the appropriate order.
- **Payload Serial Talk VRC / Payload Serial Talk 2 VRC** – Serial data received on the primary/secondary serial payload port will be tagged with this VRC and sent over-the-air.
- **Payload Serial Listen VRC / Payload Serial Listen 2 VRC** – Over-the-air payload traffic that is tagged with this VRC that the master station receives will be transmitted out of the primary payload serial port.
- **Compression** – When the Master Station is being used in a network of only SD radios in Packet-with-MAC mode and with firmware versions capable of supporting compression, enabling this option will compress over-the-air traffic resulting in less data being sent over the radio link. Depending on the type of data being transmitted, this can result in a significant throughput improvement. All nodes in the network must have compression enabled for this to function properly.
- **Encryption** – When the Master Station is being used in a network of only SD radios, over-the-air (OTA) encryption may be enabled. The Master Station uses AES-128, passphrase-based encryption to secure both payload, and Dlink traffic. If the radio is operating in transparent mode, there is a separate passphrase for payload and Dlink traffic.



If the radio is operating in packet or packet-with-MAC mode, there is a singular passphrase for all traffic.

- **Payload Encryption Phrase** – The encryption phrase to be used for over-the-air payload data. This string must be at least 8 characters, and no greater than 38 characters.

Table 5-2. Modem Selection vs. Speed, Bandwidth & Sensitivity

Modem Type Selection	Over-the-air Speed (bps)	B/W (kHz)	Approximate Sensitivity (dBm)	ETSI Compliance
BELL ¹	1200	12.5	-110	
V23	1200	12.5	-110	
3200 ^{1, 2}	3200	5.00	-108	
4800B ¹	4800	12.5	-110	
4800F	4800	6.25	-108	
9600B ¹	9600	12.5	-106	
9600 ¹	9600	12.5	-112	
9600N	9600	6.25	-98	
19200N	19200	12.5	-100	
19200	19200	25	-105	
38400N	38400	25	-99	
65000 ³	65000	50	See note 3	
4800 ¹	4800	12.5	-112	X
9600M ¹	9600	12.5	-106	X
19200E	19200	12.5	-96	X
19200M	19200	25	-106	X
38400E	38400	25	-97	X

1. For MDS x710-compatible operation.
2. 3200 bps not applicable to SD4.
3. Only available with SDM9D Radio Modules.

Dlink

Dlink is a GE MDS-proprietary protocol used for diagnostics communications.

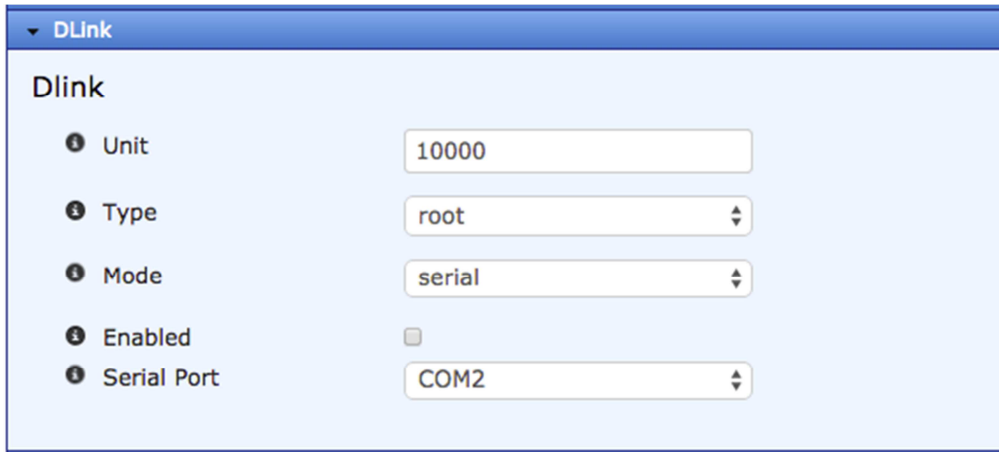

- **Unit** – This parameter identifies the radio in the wireless network with a specific ID during diagnostic sessions. For compatibility with legacy devices, the value must be 10000 or greater (2710 in hexadecimal).
- **Type** – This setting identifies the radio as a Node, Root, Repeater, Peer, or Gate. Each of these are operating modes of the transceiver with respect to diagnostic/management activities.
- **Mode** – Configure if Dlink will operate on a serial port, or via a TCP socket.
 - Serial Mode Settings:
 - **Serial Port** — This setting determines which serial port to use COM1 or COM2. This must be different than the serial payload port.
 - TCP Mode Settings:
 - **Security Mode** – When set to a value other than none, connections will be encrypted using a pre-shared key via TLS. The version specified by this parameter will be only version allowed by the server.
 - **TCP Port** – The TCP port that the Dlink service will listen on.
 - **IPv4 Addr** – Optionally configure the service to only attach to the specified IPv4 Address. This is useful when traffic is being separated into data and management VLANs. If no value is specified, the service will accept connections on all configured IP addresses.
 - **IPv6 Addr** – Optionally configure the service to only attach to the specified IPv6 Address. This is useful when traffic is being separated into data and management VLANs. If no value is specified, the service will accept connections on all configured IP addresses.
- **Enabled** – Enable or disable diagnostics functionality. Setting it to ON configures the radio to pass the diagnostic link protocol (DLINK) over the radio's COM2 management port.

MAC Settings

When operating in packet with MAC mode, MAC specific settings can be configured here.



MAC Settings

MAC Settings

1 Device Type	access-point
2 MAC Retries	1
3 Time to Live	10
4 SAF Network	<input type="checkbox"/>
5 Repeater Network	<input type="checkbox"/>
6 Payload 1 Inter Packet Gap	15
7 Payload 2 Inter Packet Gap	15
8 Transparent Rx Timeout	20

Peer to Peer

9 Peer to Peer Enabled	<input checked="" type="checkbox"/>
10 Ethernet Rebroadcast Type	unicast-and-arp

- **Device Type** – The role this device will be performing in the network. If this device is operating as a repeater, the MAC device type MUST be 'remote'.
- **MAC Retries** – If a message is not acknowledged after transmission it will be resent. This value controls how many times the radio attempts to resend the message before discarding it.
- **Time to Live** – When a message arrives from the payload interface(s) it is time-stamped and queued for radio transmission. If the radio cannot transmit the message before the Time-to-Live (TTL) value (in seconds), the message is discarded. This helps prevent stale or old data from being sent over the air.
- **SAF Network (Access Point only)** – If this device is in use in a Store-And-Forward network, enable this option.
- **Repeater Network (Access Point only)** – If this device is in use in a repeater network, enable this option.
- **Payload 1/2 Inter Packet Gap** – The inter-packet gap is a timing setting in ms used to delimit a packet on the serial interface. Too short of a time can cause serial streams to be combined into one large packet instead of two smaller ones. Too long of a time can slow down the communications channel.
- **Transparent Rx Timeout** – This setting is similar to the timing parameters for **Payload 1/2 Inter-Packet Gap**, but it applies to data received *over-the-air*. It tells the radio how to build an Ethernet packet based on a transparent data stream received over the radio channel.
- **Peer to Peer**

- Access Point Options:
 - **Peer to Peer Enabled** – If enabled, the AP will allow enabled peers to send traffic through the AP to other enabled peers by rebroadcasting their transmissions to all other remotes in the system.
 - **Ethernet Rebroadcast Type** – When rebroadcasting peer-to-peer Ethernet traffic, only the selected type of traffic will be rebroadcast to other remotes on the network.
- Remote Options:
 - **Rebroadcast Serial** – If enabled, serial traffic originating from this device will be rebroadcast by the AP to other remotes in the network. The AP must have peer-to-peer rebroadcasting enabled.
 - **Rebroadcast Ethernet** – If enabled, Ethernet traffic originating from this device will be rebroadcast by the AP to other remotes in the network. The AP must have peer-to-peer rebroadcasting enabled.

IP Payload

Under the IP Payload menu, up to three instances of the IP Payload service may be configured. The IP Payload service can operate in 4 different modes:

- TCP Server
- TCP Client
- TCP Server/Client
- UDP

Common Options:

- **Enabled** – Set to true to enable this IP Payload configuration.
- **IP Payload Mode** – The mode in which this instance of the IP Payload service should operate. The details of these modes are shown below.
- **Talk on VRC** – (Only in packet-with-mac mode) The Virtual Radio Channel that data from this IP Payload instance will be tagged with when transmitted over the air.
- **Listen to VRC** – (Only in packet-with-mac mode) Over-the-air data tagged with this Virtual Radio Channel will be handled by this IP Payload instance.
- **Modbus TCP RTU Conversion** – (Does not apply to UDP mode) When enabled, the IP Payload server will convert packets between MODBUS TCP and MODBUS RTU formats.
- **Inactivity Timeout** – When set to a value larger than 0, the connection will be closed after the specified number of seconds without any data activity.

Each of the IP Payload modes have different use cases and configuration options, as described below:

TCP Server:

The TCP server mode allows IP connections to be established with the Master Station. Data received on this TCP socket will be transmitted over the air to remote SD radios as if the data was received on the payload serial port of the Master Station. Over-the-air serial data originating from a remote SD radio will be transmitted out of this TCP socket. This mode of operation can



be thought of as a ‘remote terminal server’, not to be confused with the SD remote radio’s Terminal Server functionality.

Option	Value
Enabled	<input type="checkbox"/>
IP Payload Mode	tcp-server
Talk on VRC	vrc-1
Listen to VRC	all
Modbus TCP RTU Conversion	<input type="checkbox"/>
Local IP Port	
IPv4 Bind IP	
Inactivity Timeout	30

TCP Server specific configuration options include:

- **Local IP Port** – The TCP port number that the server will listen for connections on.
- **IPv4 Bind IP** – If the Master Station is configured with multiple IP interfaces; you can specify that the IP Payload service only will listen for connections on one of the IP addresses of the system. This is useful in VLAN configurations where you wish to only make the IP Payload server available on a specific VLAN in the system.

TCP Client:

The TCP client mode allows the Master Station to connect to a TCP server when there is traffic to send. This mode of operation is not often used in Master Station configurations, but may be useful in certain applications.

▼ IP Payload

IP Payload 1

① Enabled	<input type="checkbox"/>
① IP Payload Mode	tcp-client
① Talk on VRC	vrc-1
① Listen to VRC	all
① Modbus TCP RTU Conversion	<input type="checkbox"/>
① Server IP Address	192.168.1.2
① Remote IP Port	30001
① Inactivity Timeout	30

TCP Client specific configuration options include:

- **Server IP Address** – The IP address of the server the Master Station is to connect to.
- **Remote IP Port** – The TCP port that the server is listening on.

TCP Server/Client:

As the name implies, TCP Server/Client is a combination of the TCP Server mode, and TCP Client mode. In this mode, the Master Station will listen for incoming TCP connections and pass data exactly as in TCP Server mode. However if there is no active server connection, and over-the-air payload traffic arrives at the Master Station, the Master Station will establish an outgoing TCP connection to a remote server and transmit that data to the remote server. A use-case for this mode of operation is if you wish to have the protocol reliability of TCP, but do not wish to maintain active TCP sessions across your network.



IP Payload

IP Payload 1

Enabled	<input type="checkbox"/>
IP Payload Mode	tcp-server-client
Talk on VRC	vrc-1
Listen to VRC	all
Modbus TCP RTU Conversion	<input type="checkbox"/>
Local IP Port	30001
Server IP Address	192.168.1.2
Remote IP Port	30001
IPv4 Bind IP	<input type="text"/>
Inactivity Timeout	30

TCP Server/Client specific configuration options include:

- **Local IP Port** – The TCP port number that the server will listen for connections on.
- **Server IP Address** – The IP address of the server the Master Station is to connect to.
- **Remote IP Port** – The TCP port that the server is listening on.
- **IPv4 Bind IP** – If the Master Station is configured with multiple IP interfaces; you can specify that the IP Payload service only will listen for connections on one of the IP addresses of the system. This is useful in VLAN configurations where you wish to only make the IP Payload server available on a specific VLAN in the system.

UDP:

When operating in UDP mode, the IP Payload service uses the connectionless UDP protocol. Since UDP is connectionless, there must be receiving sockets at each end of the connection to allow for bi-directional communications. In this mode, when an application has traffic to send out over the SD network, it will establish a UDP connection to the Master Station and transmit the payload data. When the Master Station receives over-the-air payload data from remote SD radios, the Master Station will establish a UDP connection to the application and transmit the payload data. These connections are not persistent, and as such must be established for each transmission. Unlike TCP, transmissions are not guaranteed when using the UDP protocol; however UDP has a far smaller network overhead than TCP, and as such will result in lower latency.

▼ IP Payload

IP Payload 1

③	Enabled	<input type="checkbox"/>
③	IP Payload Mode	<input type="text" value="udp"/>
③	Talk on VRC	<input type="text" value="vrc-1"/>
③	Listen to VRC	<input type="text" value="all"/>
③	Local IP Port	<input type="text" value="30001"/>
③	Server IP Address	<input type="text" value="192.168.1.2"/>
③	Remote IP Port	<input type="text" value="30001"/>
③	IPv4 Bind IP	<input type="text"/>
③	Inactivity Timeout	<input type="text" value="30"/>

UDP specific configuration options include:

- **Local IP Port** – The UDP port number that the server will listen for connections on.
- **Server IP Address** – The IP address of the server the Master Station is to connect to.
- **Remote IP Port** – The UDP port that the server is listening on.
- **IPv4 Bind IP** – If the Master Station is configured with multiple IP interfaces; you can specify that the IP Payload service only will listen for connections on one of the IP addresses of the system. This is useful in VLAN configurations where you wish to only make the IP Payload server available on a specific VLAN in the system.

IPv4

This configuration section allows you to configure either a static or dynamic (DHCP) IPv4 address to the SDMS interface when it is not a member of a bridge or VLAN interface. For full information on applying IP addresses to interfaces, see the **MDS Orbit MCR Technical Manual (05-6632A01)**.



IPv4

IPv4

Enabled

Forwarding

MTU

Address

Search Add ... Delete

IP
192.168.100.1

Showing 1 to 1 of 1

Neighbor

Search Add ... Delete

IP	Link Layer Address
----	--------------------

Table is empty

DHCP

Firewall Filter

The firewall filtering rules to apply to this interface when it is not a member of a bridge or VLAN interface. For full information on applying firewall filters to interfaces, see the **MDS Orbit MCR Technical Manual (05-6632A01)**.

Filter

Filter

Input

Output

VLAN

The VLAN configuration section is used to configure the SDMS interface to be a member of a VLAN. For full information on configuring VLANs and adding interfaces to existing VLANs, see the **MDS Orbit MCR Technical Manual (05-6632A01)**.

▼ VLAN

VLAN Mode

ⓘ VLAN

NAT

The NAT configuration section is used to configure network address translation (NAT) on the SDMS interface. For full information on configuring NAT on interfaces, see the **MDS Orbit MCR Technical Manual (05-6632A01)**.

▼ NAT

NAT

Source

Destination

Static



Advanced Configuration Tab

Advanced

▼ Advanced

Advanced Settings

Soft Carrier Dekey	<input type="text" value="0"/>	milliseconds
Push to Talk Signal	<input type="text" value="off"/>	
Push to Talk Delay	<input type="text" value="0"/>	milliseconds
Clear to Send Delay	<input type="text" value="0"/>	milliseconds
Automatic Freq Correction	<input type="checkbox"/>	
Switched Carrier B Modems	<input checked="" type="checkbox"/>	
Force Dcd to Asserted	<input type="checkbox"/>	
Data Key Hold Time Out	<input type="text" value="2"/>	
Simplex Mode	<input type="checkbox"/>	
Dlink Mode B Modems	<input type="text" value="auto"/>	
Rx Mute	<input type="text" value="0"/>	milliseconds
Rx Timeout Enable	<input checked="" type="checkbox"/>	
Rx Timeout Delay	<input type="text" value="20"/>	minutes
Legacy Packet Compatibility	<input type="checkbox"/>	
Modem Receive Tolerance	<input type="text" value="normal"/>	
Modem Transmit Tolerance	<input type="text" value="normal"/>	
RSSI out Enabled	<input checked="" type="checkbox"/>	
RSSI out 0-point	<input type="text" value="-120"/>	dBm
RSSI out mV per dBm	<input type="text" value="50"/>	millivolts

- **Soft-Carrier Dekey** – Specifies how long (in ms) to wait after the removal of the keying signal before actually dropping the transmitter’s carrier. The default setting is 0, but it may be set to any value up to 255 ms. In most cases, no change is required from the default

setting. A possible exception is when the transceiver is inter-working with certain early-generation MDS radio equipment.

- **Push to Talk Signal** – Specifies the sensing polarity of the PTT line. This must be configured to one of the following values:
 - **Off** – PTT line is not used.
 - **Hi** – The PTT line is active-high.
 - **Lo** – The PTT line is active-low.
- **Push To Talk Delay** – Specifies a brief time delay after a keying event, which must expire before the radio is allowed to transmit. The allowable range is 0 to 255 ms, with the default being 0.
- **Clear To Send Delay** – Specifies a brief time delay between when an RTS (ready-to-send) signal is received and when the CTS (clear-to-send) signal is returned. The allowable range is 0 to 255 ms, and the default is 0.
- **Automatic Freq. Correction** – Automatic Frequency Correction, is used to counteract the slight RF frequency drift that may occur over time or through wide swings of ambient temperature. AFC should only be enabled when operating this device as a remote, as all remotes in the system use AFC to track the master station frequency. Under normal operation, the modem is capable of compensating for small frequency errors even with this mode disabled. Enabling AFC further extends the frequency capture range when operating with legacy hardware that may have significant frequency error.
- **Switched Carrier B Modems** – In some networks, the Master unit is not keyed continuously (Ckeyed), and transmits only when it has data to send to Remotes. This is known as Switched Carrier operation. The Switched Carrier setting is only for use on radio modems with “B” suffixes (for compatibility with MDS x710 radios). In such networks, the Remote radios should have the Switched Carrier setting turned ON. The default setting is OFF which assumes B-modem operation with a continuously keyed Master. Ckey Operation only applies to Master units operating full-duplex and does not apply to packet or packet with MAC modes. When operating continuously keyed, latency is decreased and AFC operation on legacy remotes may be improved. Switched carrier operation, when low latency is not required, is recommended when operating in high ambient conditions to reduce power consumption and heating.
- **Force DCD to Asserted** – Some systems require a constant Data Carrier Detect (DCD) signal. This setting allows the radio to be configured to provide a DCD signal without the need for special cabling.



Enabling Force DCD to Asserted will cause the RX LED on the radio interface to turn on, regardless of whether the radio is receiving data or not.

- **Data Key Hold Time-out** – When operating in data key mode, this parameter specifies the number of character-times the transmitter will remain keyed for after the last character it receives. For networks with the demand for a higher modem speed than the baud rate, this parameter can be adjusted from 1 to 10 characters. This parameter gives the overall network better performance by preventing frequent key-up and key-down sequences between characters. This only applies to networks with all SD radios.



- **Simplex Mode** – This controls whether or not the Master Station will be running in simplex (switched carrier) or full duplex mode. When simplex is enabled, TX and RX are switched onto a single RF interface. A Master Station without an internal duplexer with a single antenna output must have simplex mode enabled.
- **Dlink Mode (B Modems)** – Legacy products that only support B-Modems do not have support for Dlink. Newer products such as the MDS SD have the ability to support Dlink even when using B-Modems. Depending on site-specific requirements, this value may need to be changed to 'bypassed' in order to work with legacy products. It is recommended to leave this value set to 'auto' unless there is an explicit need to change it.
- **Rx Mute** – The number of milliseconds to mute the receiver after transmitting data. Receive muting might be required when you configure the radio as a full-duplex polling remote communicating through a repeater. It prevents the radio from hearing its own transmissions ('echoes') from the repeater, which might cause software application errors.
- **Rx Timeout Enable** – When enabled, the radio will alarm if nothing has been received over-the-air in 'Rx Timeout Delay' minutes. This can be used to detect if the receiver has failed, or if there has been a failure with the antenna.
- **Rx Timeout Delay** – When 'Rx Timeout' is enabled, this is the number of minutes to wait for a received signal before raising an alarm.
- **Legacy Packet Compatibility** – When the radio-mode is configured for packet-with-mac, enabling this option will cause the radio to operate in a legacy packet mode. This is not full packet mode as found on SD radios, as there is no support for listen-before-talk.
- **Modem Receive Tolerance** – Changes the receive tolerance of the modem. This value should always be set to normal unless instructed to change it by GE MDS technical support for specific applications.
- **Modem Transmit Tolerance** – Changes the transmit tolerance of the modem. This value should always be set to normal unless instructed to change it by GE MDS technical support for specific applications.
- **Data Device Mode (x710 mode only)** – This value controls the device behavior of the radio when operating in x710 mode. In DCE mode, CTS will go high following RTS, subject to the CTS programmable delay time. CTS KEY mode, the unit is assumed to be controlling another radio. The radio will still key based on the RTS line, but the CTS line is used as a key-line control for an external radio. CTS is asserted following the receipt of RF data, but not until after the CTS programmable time has expired. (This gives the other radio time to key.)
- **CTS Hold Time (x710 mode only)** – Used in CTS KEY mode, this command sets the amount of time in milliseconds that CTS remains present after transmission of the last character out the RXD pin of the DATA port. This 'hold time' can be used to prevent squelch tail data corruption when communicating with other radios.
- **RSSI out Enabled** – When enabled, the current RSSI value will be available as a DC voltage level on the RSSI out pin of the alarm/relay module. NOTE: This feature requires SD NICs that are capable of generating an output voltage based on RSSI. If you attempt to enable this feature on hardware that does not support it, you will receive an error message preventing you from committing the changes.

- **RSSI out 0-Point** – When RSSI out is enabled, this is the RSSI level (in dBm) that will result in an output voltage of 0 mV
- **RSSI out mV per dBm** – When RSSI out is enabled, this is the voltage (in mV) that will be produced for each dBm of signal strength above the level specified in rssi-out-0-point. E.g. Given a zero point of -120dBm, and a mv-per-dbm value of 50mV, an RSSI of -84dBm would result in an output of 1800mV.



Audio

Audio settings are only available for configuration when the radio is configured to operate in x710 compatibility mode.

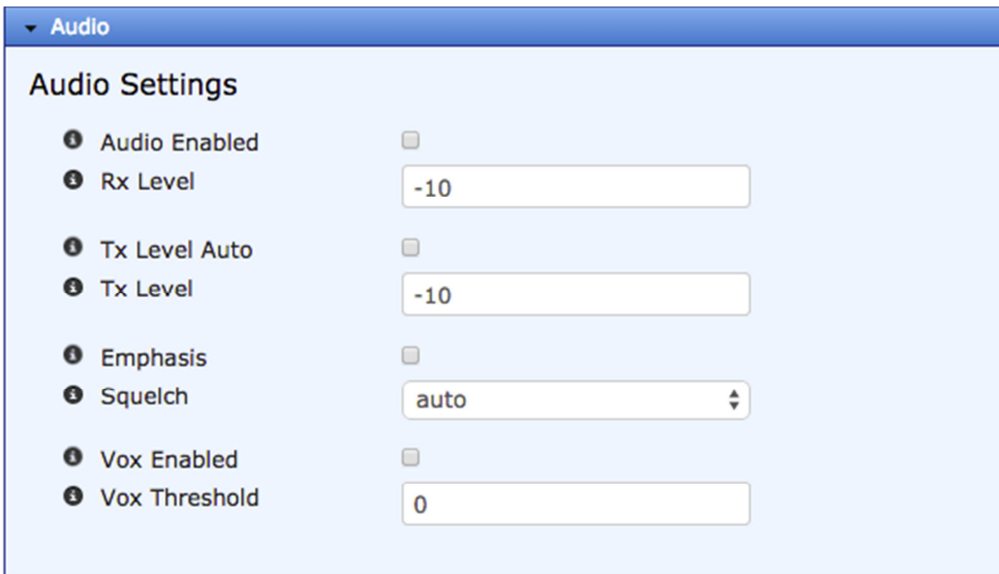

Setting	Value
Audio Enabled	<input type="checkbox"/>
Rx Level	-10
Tx Level Auto	<input type="checkbox"/>
Tx Level	-10
Emphasis	<input type="checkbox"/>
Squelch	auto
Vox Enabled	<input type="checkbox"/>
Vox Threshold	0

- **Audio Enabled** – If enabled, the radio's transmit functionality will switch to analog whenever PTT is asserted.
- **Rx Level** – Receive Audio Output Level to Modem (dBm). Received signal at the peak deviation will be scaled to the specified value. Valid range is (-20 → 0).
- **Tx Level Auto** – Automatically adjust transmit audio input level from Modem.
- **Tx Level** – Transmit audio input level from Modem (dBm). A transmit input signal of the specified value will translate into the specified peak deviation for transmit. Valid range is (-20 → 0).
- **Emphasis** – When enabled, pre-emphasis is applied on the transmitter and de-emphasis is applied on the receiver. This setting is typically used in operation with voice radios.
- **Squelch** – When set to auto, the transceiver will use its internal squelch to enable transmission of audio signals. When set to bypassed, the transceiver will transmit all audio signals regardless of level.
- **Vox Enabled** – Enables or disables the integrated VOX threshold.
- **Vox Threshold** – The audio interface on the Master Station incorporates an integrated VOX circuit to sample the voltage produced by a connected audio device. When the voltage exceeds a user-defined threshold, Push to Talk (PTT) is activated, resulting in the



transmitter being enabled. The VOX circuit detects a voltage in the range of 0-2 Volts. A single number in the range of 0-15 is used to describe the desired threshold level. For example a value of 7 is approximately 1 volt.

Enabled Alarms

This configuration section controls which of the various alarms that can be generated on the SD NIC will be propagated up to the platform manager for system logging. All alarms default to being enabled, and should remain enabled unless there is an explicit need to disable one.

Enabled Alarms		
?	Hardware Mismatch	<input checked="" type="checkbox"/>
?	Frequency Not Programmed	<input checked="" type="checkbox"/>
?	Authorization Fault	<input checked="" type="checkbox"/>
?	Synthesizer out of Lock	<input checked="" type="checkbox"/>

RTU Simulator

The unit's built-in RTU simulator generates random data similar to what would be supplied by an external RTU connected to the radio. It is useful for system testing within the radio network by providing realistic data to pass over the radio channel.

RTU Simulator	
?	RTU Enabled <input checked="" type="checkbox"/>
?	RTU Number <input type="text" value="1"/>

- **RTU Enabled** – Enable the built-in RTU simulator.
- **RTU Number** – The RTU number the simulator will respond to requests for.

Remote SD Reprogramming

This section contains various parameters for the broadcasting of new firmware to remote SD radios. Please see section “Remote SD Reprogramming” below.

Actions Tab

Force Alarm

From the Force Alarm menu, you can force the SD radio interface cards to enter a test alarm state. To activate an alarm, select which radio slot to alarm, and click the Perform action button. An “Alarm Test” entry will be created in the Event Log and the external alarm output status is changed. This can be useful when testing event logging and propagation across a network, or when testing equipment connected to the alarm output contacts on the Master Station. When en-

abled, the alarm will assert for 30 seconds, and then deactivate. If active, it can be manually deactivated prior to timeout by deselecting the slot number of the radio and clicking the Perform action button again.

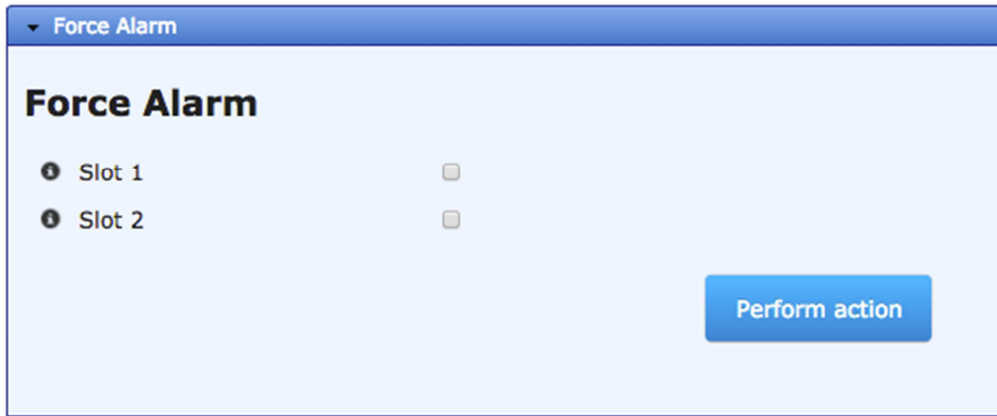

Link Test

The primary use of the Link Test is to verify that a specific radio's settings are consistent with the initiator including: Assigned frequency, unit number setting, encryption (if enabled), etc. Also collected at the same time is an indication of link quality. All radios are always ready to respond to a Link Test message. Only the initiating radio requires configuration when using the Link Test screen and it is only available when operating in Packet w/MAC mode.

A summary of data statistics is displayed on the right side of the screen, including transmit/receive packet counts, total bits, and total number of bit errors.

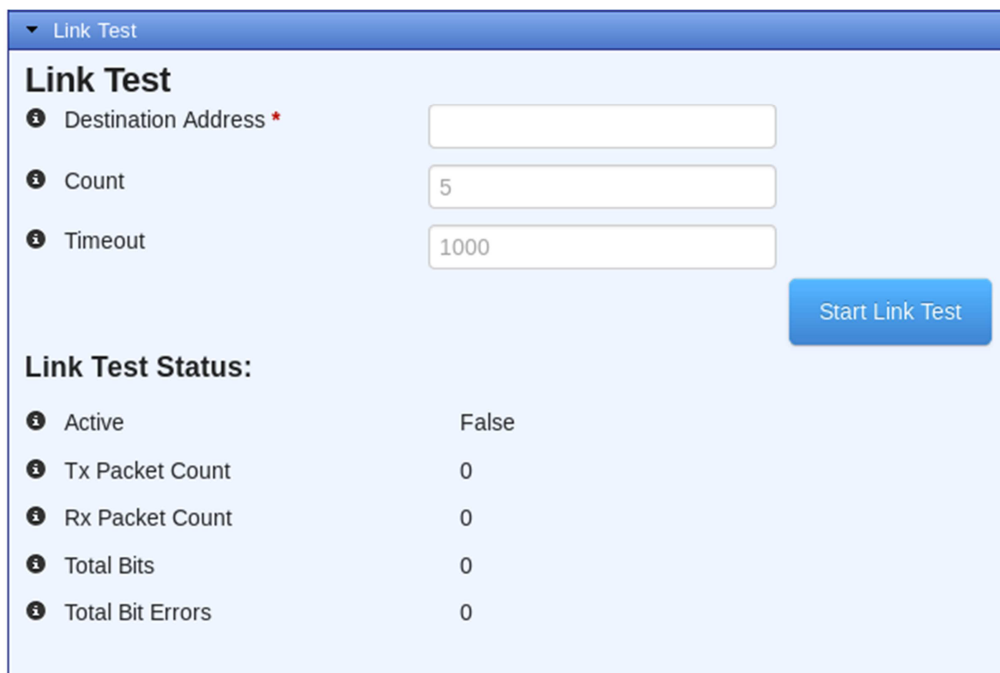

Link Test Status:	
Active	False
Tx Packet Count	0
Rx Packet Count	0
Total Bits	0
Total Bit Errors	0

- **Destination Address** – The unit address of the other radio being tested.
- **Count** – The number of times for the message to be sent across the radio link.



- **Timeout** – The time (in milliseconds) that will result in a timeout if no response is received within that period.

Perform Failover

If the Master Station is equipped with redundant SD radios, the active radio can be manually toggled by selecting the “Perform” action.



The manual toggle-switch on the alarm/relay board must be in the ‘Automatic’ position for this operation to succeed. The toggle-switch will override all software-based control of which radio is active.

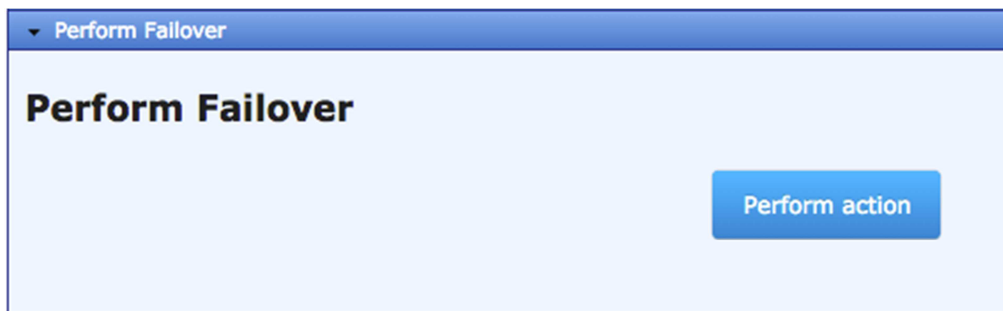

Remote Management Command

The Master Station has the ability to broadcast management commands to remote SD radios in the network. These commands are sent to all connected remote radios, and hence should only be used for making network-wide changes.

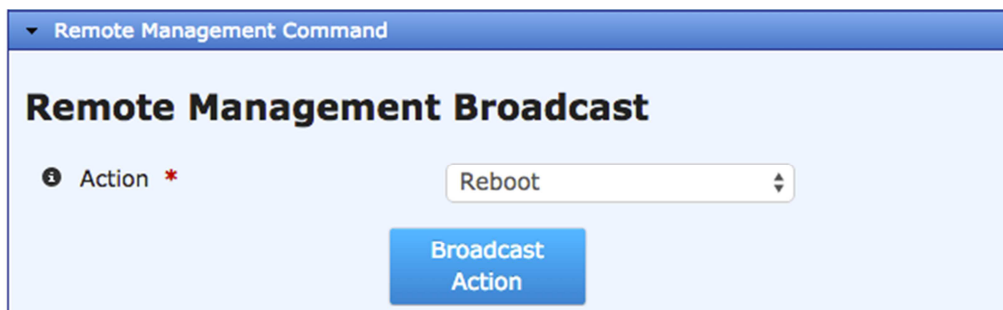

The following action can be specified:

- **Reboot** – All remote radios will reboot to the currently active firmware image.
- **Set Radio Mode** – Change the radio mode of remote radios (x710/transparent/packet/packet-with-MAC)
- **Set Frequencies** – Set the receive and transmit frequencies of remote radios.
- **Set Modem Type** – Change the configured modem of remote radios.
- **Set Transmit Tolerance** – Change the configured transmit tolerance of remote radios.
- **Set System ID** – Change the configured system ID of the remote radios.
- **Enable Bridge** – Enable or disable Ethernet bridging on remote radios.
- **Enable Encryption** – Enable or disable OTA encryption on remote radios.

- **Set Payload Encryption Phrase** – Change the payload encryption phrase on remote radios.
- **Set Dlink Encryption Phrase** – Change the Dlink encryption phrase on remote radios. (Only used in transparent mode)
- **Set SCD** – Change the Soft Carrier Dekey value on the remote radios.
- **Repeater Network Change** – Change remote parameters that may need to be configured when running in a network which uses a MDS™ Master Station as a repeater.



With the exception of the reboot command, these actions will cause permanent loss in connectivity to the Master Station until the corresponding configuration changes are made to the Master Station itself.

Remote SD Firmware

Please see section “Remote SD Reprogramming” below.

RF Key Test

Using the RF Key Test action, the active radio can be manually keyed (transmitter enabled) or de-keyed (transmitter disabled). This may be useful when diagnosing signal-strength on a remote receiver.

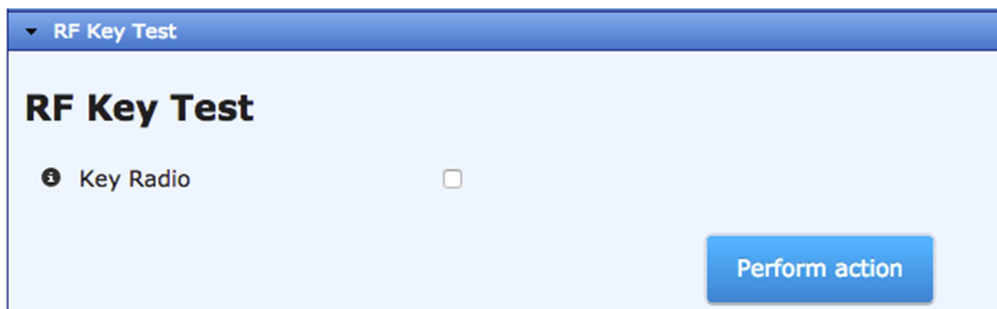

Spectrum Analyzer

A unique feature of the transceiver is the ability to view the RF spectrum above and below the operating frequency using its built-in Spectrum Graph. Often, this can assist in diagnosing the cause of interference, or to view other signals near your operating frequency. To use the Spectrum Graph, you must first specify a center frequency and a scan width. The center frequency is the frequency that you wish the spectrum display to be centered on. The span frequency defines the width of the overall spectrum to be examined.

Once the correct values have been entered, switch it on by sliding the on/off switch. The graph will automatically refresh itself every 5 seconds. To stop scanning, turn the on/off switch off.

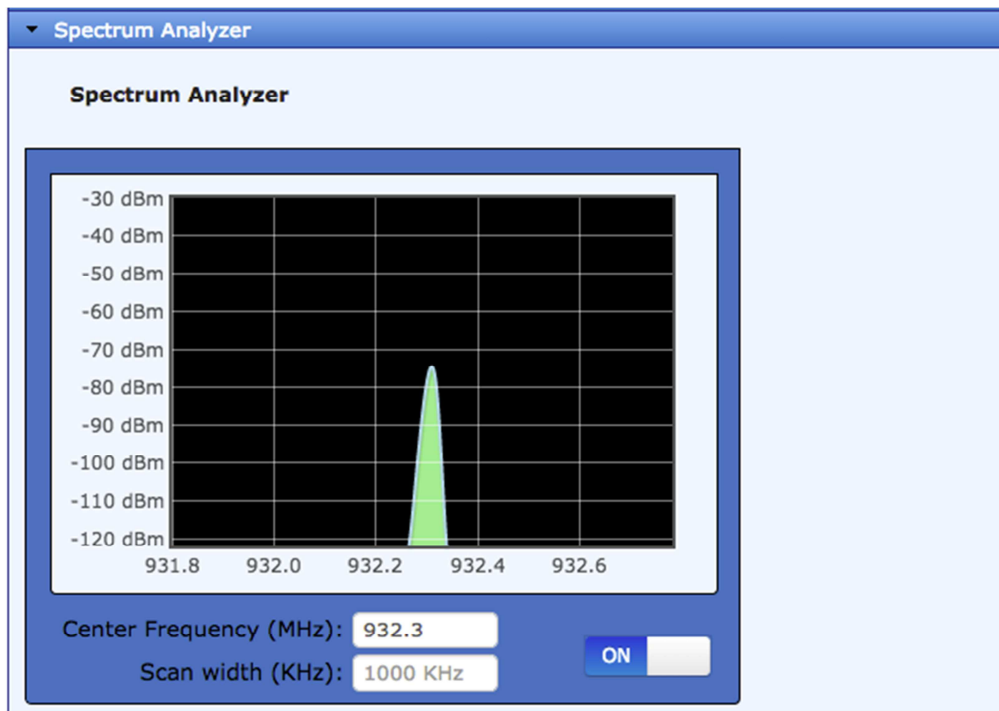

Remote SD Reprogramming

OTA Reprogramming Overview



This feature is for reprogramming SD remote radios only. This will not reprogram other Master Stations on the network.

The “Root” is the central location from which polling originates. Other locations in the network should be designated as “Nodes” which are the receiving stations. Over-the-air firmware upgrades should always be initiated from the Root. This ensures that all radios in the network will be properly updated.

The Master Station broadcasts a series of messages to one or more remote nodes to accomplish the reprogramming process. The “broadcast” method is used to program the greatest number of radios in the shortest amount of time; however, the Master Station remains unaware of the number or success of downstream radios participating in reprogramming.

During reprogramming, the status of the reprogramming will be available on all the radios participating in the process. Because the initiator is “broadcast-only” this status can only indicate progress toward sending out of all of the messages. On the nodes, the progress toward completion of reception of reprogramming information is indicated.

Receiving stations can automatically reboot to the new image after successful reprogramming. Alternatively, there is an OTA reboot command that can be broadcast from the Master Station to all receiving stations. This last option instructs the receivers to reboot to a specific firmware revision if available, and not already running at that revision.

Reprogramming Parameters:

The setting for over-the-air reprogramming are found under the “Advanced Config” tab on the web UI.

Remote SD Reprogramming

Reprogramming Parameters

Channel Usage	<input type="text" value="passive"/>
Block Size	<input type="text" value="512"/>
Auto Reboot	<input checked="" type="checkbox"/>
Packet Size	<input type="text" value="40"/>
Retry Count	<input type="text" value="3"/>
Download Delay	<input type="text" value="short"/>

- **Channel Usage** – Set to either Intrusive or Passive as desired.
 - **Passive (Non-intrusive)** operation “piggy-backs” reprogramming data onto normal payload data streams, thus allowing payload data to continue uninterrupted, but will be slower than intrusive operation. This mode requires payload data to be sent so that the reprogramming data can be carried. See Table 5-3 for reprogramming times.
 - **Intrusive** operation means that the payload application data will be interrupted while programming data is sent over the air. This is the fastest method of programming radios over the air, but it comes at the cost of interruptions in the primary use of the radio network. For best results, data polling should be stopped during Intrusive Reprogramming. See Table 5-4 for reprogramming times.
- **Block Size** – Sets the overall block size (in bytes) of each data packet. Default setting is 512.
- **Auto-Reboot** – When enabled, the remote radios will automatically reboot after a firmware image upgrade. If disabled, the newly loaded image will not become valid until the remote radio is rebooted manually.
- **Packet Size** – Specifies the size of the reprogramming data packets. Default size is 40.
- **Retry Count** – Specifies the number of times each transmission is repeated. Default setting is 3. Decreasing this value will decrease reprogramming times, but increase the chance of a remote radio not properly receiving a packet.
- **Download Delay** – Introduce a time delay before reprogramming begins. Typically, it is set to Short, but may be increased incrementally by selecting one of the extended delay times from the drop-down box (Short, Medium, Long, None)



Table 5-3. Approximate Reprogramming Times - Passive Mode

Modem Speed (bps)	Approximate Time Required
4800	6 hours
9600	1 hour, 30 minutes
19200	1 hour, 30 minutes



Radio assumptions: Signal strength -85 dBm or stronger, Packet Size: 40, Block Size: 512, Retry: 3, Download Delay: Short.

Polling assumptions: Serial polling with 1-second poll time, sending random data at 50-100 bytes. Slower polling times will significantly increase completion time.

Table 5-4. Approximate Reprogramming Times - Intrusive Mode

Modem Speed (bps)	Approximate Time Required
4800	1 hour, 30 minutes
9600	30-45 minutes
19200	20-25 minutes



Radio assumptions: Signal strength -85 dBm or stronger, Packet Size: 40, Block Size: 512, Retry: 3, Download Delay: Short

Polling assumptions: Polling should be temporarily suspended while OTA reprogramming is active.

Start Reprogramming

When ready to reprogram the SD firmware, click the Start Reprogramming action.

- **File Source** – There are many file transfer protocols supported, select Local File to upload directly from your browser, or HTTP / FTP / SFTP / TFTP to have the MDS™ Master Station retrieve the file from a remote server.
- **Local File** (Browser Upload) – Click the “Select File” to choose a file, and press “Begin Reprogramming”
- **URL** (HTTP only) – Enter a valid URL (e.g <http://192.168.1.1/file.mpk>) pointing to the firmware.
- **Server Address** (All) – Use this field to enter a valid IP address for the host computer (where file to be transferred resides).

- **File Path** (TFTP/SFTP/FTP) – This field is used to enter the exact name of the file and path to be imported.
- **Block Size** (TFTP) – The TFTP block size to use when transferring the file. Default is 1024.
- **Port** (TFTP) – The TCP port that the TFTP server is operating on.
- **User Name** (SFTP/FTP) – The user to connect to the SFTP/FTP server as.
- **Password** (SFTP/FTP) – The password for the SFTP/FTP server.
- **Control Port** (SFTP/FTP) – The TCP port that the SFTP/FTP server is operating on. Default is 22 for SFTP and 21 for FTP.
- **Data Port** (FTP) – The TCP port that the FTP server uses for data connections. Default is 20.
- **Timeout** (All) – Determines the amount of time (in seconds) that the radio should wait for server to respond. The default setting is 30 seconds and will not normally require any change.

When the above fields have been set and you are ready to load a new file, click the Begin Reprogramming button to begin reprogramming. To view the current status of the remote reprogramming operation, navigate to the sdms interface status page.

Cancel Reprogramming

During the reprogramming operation the user has the ability to cancel reprogramming at any time either on the Master Station, which will affect all radios, or on individual receiving stations. Note that cancelling reprogramming at the Master Station results in all radios in the network having only one (instead of two) applications programmed in their image banks. That is, the “inactive” image (which was only partially upgraded) will be corrupt and unusable until reprogrammed at a later time.

Reprogramming Status

Once reprogramming has begun, the current reprogramming status will appear beneath the “Cancel Reprogramming” button.

Reprogramming Status

Current State	cancelled
Details	Cancelled reprogramming of remote SD firmware
Percent Complete	<div style="border: 1px solid #ccc; width: 100px; height: 15px; display: flex; align-items: center; justify-content: center;"> 0% </div>

Monitoring

Statistics

Interfaces → *sdms* → *Status* → *Statistics*



▼ Statistics		
ⓘ Discontinuity Time*	Thu, 23 Jul 2015 17:34:26 GMT	<input type="button" value="Refresh"/> every <input type="text"/> seconds
ⓘ In Octets	0	
ⓘ In Unicast Pkts	0	
ⓘ In Multicast Pkts	0	
ⓘ In Discards	336	
ⓘ In Errors	0	
ⓘ Out Octets	4718384	
ⓘ Out Unicast Pkts	41756	
ⓘ Out Discards	0	
ⓘ Out Errors	0	

- **Discontinuity Time** – The time on the most recent occasion at which any one or more of this interface’s counters suffered a discontinuity or interruption of service.
- **In Octets** – The total number of octets received on the interface, including framing characters.
- **In Unicast Pkts** – The number of packets, delivered by this sub-layer to a higher (sub-)layer, which were not addressed to a multicast or broadcast address at this sub-layer.
- **In Multicast Pkts** – The number of packets, delivered by this sub-layer to a higher (sub-)layer, which were addressed to a multicast address at this sub-layer.
- **In Discards** – The number of inbound packets which were chosen to be discard even though no errors had been detected to prevent their being deliverable to a higher-layer protocol. One possible reason for discarding such a packet could be to free up buffer space.
- **In Errors** – For packet-oriented interfaces, the number of inbound packets that contained errors preventing them from being deliverable to a higher-layer protocol.
- **Out Octets** – The total number of octets transmitted out of the interface, including framing characters.
- **Out Unicast Pkts** – The total number of packets that higher-level protocols requested be transmitted and which were not addressed to a multicast or broadcast address at this sub-layer, including those that were discarded or not sent.
- **Out Discards** – The number of outbound packets which were chosen to be discarded even though no errors had been detected to prevent their being transmitted.
- **Out Errors** – For packet-oriented interfaces, the number of outbound packets that could not be transmitted because of errors.

Performance

Interfaces → sdms → Status → Performance

▼ Performance

Measured RF Power	36 dBm	Refresh	every <input style="width: 30px;" type="text"/> seconds
Signal to Noise	23 db		
RSSI	-87 dBm		

- **Measured RF Power** – Read-only indication of the measured RF output power (in dBm).
- **Signal to Noise (SNR)** – Read-only indication of the signal-to-noise ratio of the received signal.
- **RSSI** – Read-only indication of the measured received signal strength (in dBm).

IPv4 / IPv6

▼ IPv4

MTU 1500

Address

📶
🔄
👁️
🔍
🔧

IP	Origin
Table is empty	

Neighbor

📶
🔄
👁️
🔍
🔧

IP	Link Layer Address	Origin	State
Table is empty			

▶ IPv6

5.10 SD-x/0/0 Interfaces

Configuration for each SD Radio Modules is done via the SDMS interface. Each individual interface provides statistics for serial, IP payload and MAC that could be helpful in a debugging situation.

General

Interfaces → sd-x/0/0 → Status / General







sd-1/0/0 Interface

Status

Basic Config

▼ General

	Type*	sd-nic	Refresh every <input type="text" value=""/> seconds
	Admin Status*	up	
	Oper Status*	up	
	IF Index*	4	

▶ Statistics

This screen is read-only and displays the status of the SD NIC interface.

Statistics

Interfaces → *sd-x/0/0* → *Status / Statistics*

Sd Statistics

This section will contain statistics on the MAC, COM Ports, and IP Payload (1-3).

▼ Statistics

	Discontinuity Time*	Thu, 23 Jul 2015 17:34:26 GMT	Refresh every <input type="text" value=""/> seconds
---	---------------------	-------------------------------	---

Sd Statistics

Com 1 Tx Bytes	0
Com 1 Rx Bytes	0
Com 2 Tx Bytes	0
Com 2 Rx Bytes	0
Pmux Tx Packets	48879
Pmux Rx Packets	224
Com 1 Tx Packets	0
Com 2 Tx Packets	0
Eth Tx Packets	48679

- **Discontinuity Time** - The time on the most recent occasion at which any one or more of this interface's counters suffered a discontinuity or interruption of service.
- **Com 1 Tx Bytes** – The total number of transmitted bytes on the COM1 port.
- **Com 1 Rx Bytes** – The total number of received bytes on the COM1 port.
- **Com 2 Tx Bytes** – The total number of transmitted bytes on the COM2 port.
- **Com 2 Rx Bytes** – The total number of received bytes on the COM2 port.

- **Pmux Tx Packets** – The total number of data packets transmitted.
- **Pmux Rx Packets** – The total number of data packets received.
- **Com 1 Tx Packets** – The total number of transmitted packets on the COM1 port.
- **Com 2 Tx Packets** – The total number of transmitted packets on the COM2 port.
- **Eth Tx Packets** – The total number of transmitted packets on the Ethernet port.

IP Payload (1, 2 or 3) Statistics

IP Payload 1 Statistics	
Tx Packets	0
Rx Eth Bytes	0
Rx Eth Packets	0
Tx Eth Bytes	0
Tx Eth Packets	0
Rx Radio Bytes	0
Rx Radio Packets	0
Tx Radio Bytes	0
Tx Radio Packets	0
Rx Radio Failed Bytes	0
Rx Radio Failed Packets	0
Tx Eth Failed Bytes	0
Tx Eth Failed Packets	0
TCP Keepalive Timeouts	0

- **Tx Packets** – Total number of transmitted packets.
- **Rx Eth Bytes** – Total number of received bytes on the Ethernet.
- **Rx Eth Packets** – Total number of received packets on the Ethernet.
- **Tx Eth Bytes** – Total number of transmitted bytes on the Ethernet.
- **Tx Eth Packets** – Total number of transmitted packets on the Ethernet.
- **Rx Radio Bytes** – Total number of received bytes through the radio.
- **Tx Radio Bytes** – Total number of transmitted bytes through the radio.
- **Tx Radio Packets** – Total number of transmitted packets through the radio.
- **Rx Radio Failed Bytes** – Total number of received bytes failed through the radio.
- **Rx Radio Failed Packets** – Total number of received packets failed through the radio.

- **Tx Eth Failed Bytes** – Total number of transmitted bytes failed on the Ethernet.
- **Tx Eth Failed Packets** – Total number of transmitted packets failed on the Ethernet.
- **TCP Keepalive Timeouts** – Total number of TCP Keepalive Timeouts by the radio.

MAC Statistics

MAC Statistics	
MAC Tx Frames	15057577
MAC Rx Frames	448
MAC Checksum Fails	0
MAC Tx Data Frames	48879
MAC Tx Contention Frames	15008251
MAC Tx Contention Grants	224
MAC Tx Contention Requests	0
MAC Rx Data Frames	224
MAC Rx Contention Grants	0
MAC Rx Contention Requests	224
MAC Retries	0
MAC Acknowledgements	0
MAC Ttl Expirations	0

- **MAC Tx Frames** – Total number of transmitted frames on the MAC.
- **MAC Rx Frames** – Total number of received frames on the MAC.
- **MAC Checksum Fails** – Total number of checksum failures on the MAC.
- **MAC Tx Data Frames** – Total number of transmitted data frames on the MAC.
- **MAC Tx Contention Frames** – Total number of transmitted contention frames on the MAC.
- **MAC Tx Contention Grants** – Total number of transmitted contention grants on the MAC.
- **MAC Tx Contention Requests** – Total number of transmitted contention requests on the MAC.

- **MAC Retries** – Total number of retries on the MAC.
- **MAC Acknowledgements** – Total number of MAC frames acknowledged by the access point. (when operating as a remote)
- **MAC TTL Expirations** – Total number of frames dropped due to expired time-to-live counters.

6.0 MASTER STATION MODULES

The available modules are listed below and described in the following sections. To aid identification, most modules have their 4-digit base part number printed on the faceplate. These are the 4 numeric digits following 03- prefix.

Table 6-1. Available Modules

Identifier	Item	Description
6755	100-220V AC Power Supply Module	100-220 VAC, 50/60 Hz. 120W Max AC Power Supply Module. Spare power supply can be used in either of two power supply slots of the MDS™ Master Station.
6834	Platform Manager Module	Provides management and data interface functions.
6837	Duplexers	Spare duplexer in tray wired for MDS™ Master Station.
6843	+/- 12-36 V DC Power Supply Module	+/- 12-36 VDC. 10 A Max. DC Power Supply Module. Spare power supply can be used in either of two power supply slots of the MDS™ Master Station.
6844	+/- 36-75 V DC Power Supply Module	+/- 36-75 VDC. 3.5 A Max DC Power Supply Module. Spare power supply can be used in either of two power supply slots of the MDS™ Master Station.
6845	+/- 75-140 V DC Power Supply Module	+/- 75-140 VDC. 2 A Max DC Power Supply Module. Spare power supply can be used in either of two power supply slots of the MDS™ Master Station.
6846	SDM9 or SDM4 Radio Module	Full duplex SD-compatible radio module.
6847	Redundant Alarm/Relay Module	Active radio relay and alarm/audio interface.
6848	None-Redundant Alarm Module	Non-redundant—Alarm and audio interface.

6.1 AC Power Supply Module



Figure 6-1 AC Power Supply Module
(Part No. 03-6755A02: 110/220 VAC)

Table 6-2. 6755 AC Power Supply Module Specifications

Supply Type	SMPS AC to DC
Input Voltage Range	100-264 VAC
Output	24 VDC, 4.0A
Line Frequency	50-60Hz
Power Consumption	120W, Maximum
Protection	Integrated thermal protection, short circuit protection, internal non-serviceable fuse
Ambient Temperature range	Full capacity from -30°C to +60°C. CSA certified operating range -30°C to +39°C.

NOTICE Master station power supply modules are field replaceable units that can be removed from an operating system *so long as the input power source to the module being replaced has been disconnected*. Refer to Section 7.4 Replacing Modules for information on removal and installation.

NOTICE When installing AC Power Supply modules, torque thumbscrews to 10 in-lbs to insure optimum heat transfer through thermal contact connector on the rear of the unit.

6.2 DC Power Supply Module



Figure 6-2. DC Power Supply Module

Including: 03-6843A01: +/- 12-36 VDC
 03-6844A01: +/- 36-75 VDC
 03-6845A01: +/- 125 VDC



Table 6-3. DC Power Supply Module (6843, 6844, 6845) Specifications:

Supply Type	SMPS DC to DC
Input Voltage Range	+/-36-75 VDC, input is isolated from ground +/-12-36 VDC, input is isolated from ground +/-75-140 VDC, input is isolated from ground
Output	24 VDC, 4.0 A
Line Frequency	DC Input only
Power Consumption	120W, Maximum
Protection	Integrated thermal protection, short circuit protection, internal fuse
Ambient Temperature range	Full capacity from -30°C to +60°C CSA Certified operating range -30°C to +50°C

CAUTION Master station power supply modules are field replaceable units that can be removed from an operating system *so long as the input power source to the module being replaced has been disconnected*. Refer to Section 7.4 Replacing Modules for information on removal and installation.

CAUTION DC power supply modules are available for several different input ranges. These modules have interchangeable connectors. Make sure the supply is within the rating for the module installed.

NOTICE When installing DC Power Supply modules, torque thumbscrews to 10 in-lbs to insure optimum heat transfer through thermal contact connector on the rear of the unit.

6.3 Platform Manager Module



Figure 6-3 Platform Manager Module
(Part Numbers 03-6834Axx)

The Platform Manager module is an orbit based management processor that provides Ethernet and serial connectivity to radio cards connected on the Master Station backplane. This module

features a 10-port Ethernet switch and USB hub for backplane connectivity to a number of radio modules.

NOTICE The Platform Manager module does not support hot swappable field replacement; power must be removed from the system before removal or installation of this device. Refer to Section 7.4 Replacing Modules for information on removal and installation.

The Platform manager is available with and without GPS for time of day and synchronization purposes for future radio module offerings. When ordered with WiFi, the Platform Manager module may be configured using a tablet, smartphone, or other WiFi enabled web device.

The Interfaces on the front panel of the Platform Manager are described below. Note that the small connector on the bottom right, just above the part number, is currently unused.

Platform Manager LED Indicators

The Platform Manager has BLUE LEDs to indicate Platform Manager power on, system initialization, and Master Station alarm status. The behavior of these LEDs is described below.

Table 6-4. Platform Manager LEDs

LED Name	Behavior	Meaning
PWR	BLUE FLASHING	Power Applied System Initialization
ALARM	BLUE FLASHING BLUE OFF	Pre-boot Validation or System Initialization Master Station Alarm No Alarm

Ethernet Interfaces

The Ethernet interfaces have built-in MDIX (auto-sensing) capability, allowing either a straight-through or crossover cable to be used.

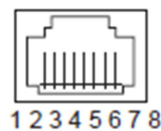

Figure 6-4. Ethernet Port (RJ-45) Pinout
(As viewed from the outside)

Table 6-5. Ethernet Interface Pin Descriptions

Pin	Functions	Ref.
1	Transmit Data (TX)	High
2	Transmit Data (TX)	Low
3	Receive Data (RX)	High
4	Unused	
5	Unused	
6	Receive Data (RX)	Low
7	Unused	
8	Unused	

COM1 Interface

COM1 supports the RS-232 serial data format at serial data rates of 300, 1200, 2400, 4800, 9600, 19200, 38400, 57600, and 115200 bps (asynchronous only).

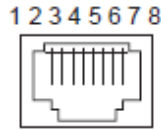

Figure 6-5 COM1 Connector (RJ-45)

(As viewed from outside the unit)



COM1 is hard-wired as a DCE device.

Table 6-6. COM1 Pin Descriptions

Pin Number	Radio Input/Output	Pin Description
1	OUT	DSR (Data Set Ready)
2	OUT	DCD (Data Carrier Detect/Link) —A high indicates signal received.
3	IN	DTR (Data Terminal Ready)
4	--	Ground —Connects to ground (negative supply potential) on chassis.
5	OUT	RXD (Received Data) —Supplies received data to the connected device. Ground —Connects to ground (negative supply potential) on chassis.
6	IN	TXD (Transmitted Data) —Accepts TX data from the connected device.
7	OUT	CTS (Clear-to-Send) —Can be used for flow control or as an output to key another connected radio.
8	IN	RTS (Request-to-Send) —Can be used for flow control or to key the transmitter.

COM2 Interface

The COM2 port supports the RS-232 or RS-485 serial data format at serial data rates of 300, 1200, 2400, 4800, 9600, 19200, 38400, 57600, and 115200 bps (asynchronous only).

Pin Descriptions—RS-232 and RS-485

Pin descriptions for the COM2 data port in RS-232 mode and RS-485 modes are provided below.



In addition to RS-485 mode, the radio is capable of operating in RS-422 mode. Configure the port for RS-485 but follow the RS-422 wiring arrangements shown in below under COM2 RS-485 and RS-422 Wiring Arrangement.

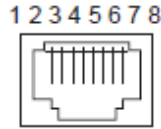

Figure 6-6. COM2 Connector (RJ-45)
(As viewed from outside the radio)



COM2 is hard-wired as a DCE device.

Table 6-7. COM2 Pin Descriptions—Radio in RS-232 Mode

Pin Number	Radio Input/Output	Pin Description
1	--	Reserved—Do not connect
2	--	Reserved—Do not connect
3	--	Reserved—Do not connect
4	-	Ground —Connects to ground (negative supply potential) on the radio's PC board.
5	OUT	RXD (Received Data) —Supplies received data to the connected device.
6	IN	TXD (Transmitted Data) —Accepts TX data from the connected device.
7	OUT	CTS (Clear-to-Send)
8	IN	RTS (Request-to-Send)

Table 6-8. COM2 Pin Descriptions—Radio in RS-485 Mode

Pin Number	Radio Input/Output	Pin Description
------------	--------------------	-----------------

Table 6-7. COM2 Pin Descriptions—Radio in RS-232 Mode

Pin Number	Radio Input/ Output	Pin Description
1	--	Reserved—Do not connect
2	--	Reserved—Do not connect
3	--	Reserved—Do not connect
4	-	Ground —Connects to ground (negative supply potential) on the radio's PC board.
5	IN	TXD+/TXB (Transmitted Data +)— Non-inverting receiver input
6	OUT	RXD+/RXB (Received Data +)—Non-inverting driver output.
7	IN	TXD-/TXA (Transmitted Data -)— Inverting receiver input
8	OUT	RXD-/RXA (Received Data -)— Inverting driver output.

COM2 RS-485 and RS-422 Wiring Arrangement

- RXD+ / RXB and RXD- / RXA are data received by the radio and transmitted
- RXD+ / RXB is positive with respect to RXD- / RXA when the line input is a “0”
- TXD+ / TXB and TXD- / TXA are data sent to the radio to be transmitted
- TXD+ / TXB is positive with respect to the TXD- / TXA when the line output is a “0”

Table 6-9. EIA-422 4-Wire Connections

External DB-9		COM2	
TXD-	2	7	TXD-
RXD-	3	8	RXD-
RXD+	7	6	RXD+
TXD+	8	5	TRD+

Table 6-10. EIA-485 2-Wire Connections

External DB-9		COM2	
TXD-	2	RXD-/TXD-	
RXD-	3		
RXD+	7	RXD+/TXD+	
TXD+	8		

Mini USB Interface

The USB Interface follows standard Mini-USB wiring and protocol. This interface can be used to access a command line user interface when connected to a computer USB port and the GE provided driver is installed. Refer to “Mini USB” on Page 23 for more information.

WiFi Antenna Interface (Optional)

Integrated WiFi is a future option.

GPS Antenna Interface (Optional)

Integrated GPS is a future option.

6.4 SD Master Radio Modules



**Figure 6-7. SD Radio Module
(Part No. 03-6846A01-xx)**

The SD Master Radio Modules are field replaceable, hot swappable, full duplex radios offering narrowband communications. Current offerings include variants that span 800-960MHz.

NOTICE Master station Radio modules are field replaceable and hot swappable. Refer to Section 7.4 Replacing Modules for information on removal and installation.

NOTICE When installing Radio Modules, torque thumbscrews to 10 in-lbs to insure optimum heat transfer through thermal contact connector on the rear of the unit.

SD Master Radio Module LED Indicators

The SD Radio Modules have bi-color green/red LEDs to indicate power, alarm, and active/standby status as shown in the table below. Blue LEDs to indicate receiver transmit and receive are also provided.

Table 6-11. SD Radio Module LEDs

LED Name	Behavior	Meaning
PWR/ALARM	GREEN	Power applied
	FLASHING RED	Alarmed radio
	FLASHING GREEN	Radio power-up
	Alternating with ACTIVE	Firmware is updating
ACTIVE	GREEN	Active
	OFF	Standby
	Alternating with PWR	Firmware is updating
TX	BLUE	Transmitting
RX	BLUE	Receiving

SD Master Radio Module RF Interface

SD Radio Modules include keyed RF Connectors for front connection to either an Alarm/Relay Module, if used in a redundant system, or to the front of the duplexer tray if used in a non-redundant system. Different cables are used in each case. Systems assembled by the factory come pre-wired using the appropriate cabling. If replacing a module, use the cables provided with the original system. For more information refer to the appropriate section below for the specific Radio Module.

SDM9 Radio Module – 900MHz

The SDM9 is an SD Master Radio Module with several variants to accommodate different frequency bands. Current offering is the SDM9C which supports 928-960MHz. Refer to the table below for detailed information about this transceiver.

Table 6-12. 6846 SDM9 Radio Module Specifications

Frequency Band	820-870MHz (Pending)
	880-915MHz (Pending)
	928-960MHz (SDM9C)
Duplex Modes	Full
	Half Duplex, Switched Carrier
	Half Duplex, Single Carrier (Simplex)
Transmit Power	Half Duplex modes may operate using software enabled integrated T/R switch for installations that do not require a duplexer.
	+40dBm, Maximum. Software programmable from _+30 to +40dBm in 1dB steps.
Receive Noise Figure	<6dB
Adjacent Channel Rejection	60dB typical (EN300-113)
Power Consumption	60W, Max, at full duplex with continuous transmit, +40dBm
Antenna Connector	Dual FAKRA-SMB

SDM4 Radio Module - 400 MHz

The SDM4 is an SD Radio Module with variants to accommodate different frequency bands. Current offering includes the SDM4B which supports 400-450MHz and the SDM4C which supports 450-512MHz. Refer to the table above for detailed information about this transceiver.

Table 6-13. 6846 SDM4 Radio Module Specifications

Frequency Band	400-450MHz (SDM4B) 450-512MHz (SDM4C)
Duplex Modes	Full Half Duplex, Switched Carrier Half Duplex, Single Carrier (Simplex) Half Duplex modes may operate using software enabled integrated T/R switch for installations that do not require a duplexer.
Transmit Power	+41.1dBm, Maximum. Software programmable from +30 to +40dBm in 1dB steps.
Receive Noise Figure	<6dB with AGC at maximum gain
Adjacent Channel Rejection	60dB, minimum (EN300-113)
Power Consumption	60W, Max, at full duplex with continuous transmit, +40dBm
Antenna Connector	Dual FAKRA-SMB

6.5 Alarm and Alarm/Relay Modules



Figure 6-8 Alarm/Relay Module
(Part No. 03-6847Axx; 03-6848Axx)

There are 2 versions of the Alarm Module depending on whether the system is redundant or non-redundant. The module pictured above is for redundant systems.

Table 6-14. Alarm Modules

Part Number	Description	System	Interfaces and Indicators
03-6847Axx	Alarm/Relay Module	Redundant	RX/TX RF Connection for Radio A, Radio B, and OUT. Relay to switch RF OUT based on active A or B. Toggle Switch to select active A/B or Auto Alarm and Active LEDs Alarm/Audio Connector
03-6848Axx	Alarm Module	Non-Redundant	Does not include RF Connections Does not include Relay Does not include Toggle Switch Alarm and Active LEDs



Table 6-14. Alarm Modules

Part Number	Description	System	Interfaces and Indicators
			Alarm/Audio Connector

Both versions of this module provide user connections for external alarm dry contacts and four wire audio.

NOTICE The Alarm or Alarm/Relay module does *not* support hot swappable field replacement; power must be removed from the system before removal or installation of this device. Refer to Section 7.4 Replacing Modules for information on removal and installation.

Alarm Module LEDs

The Alarm Module includes LEDs to indicate the active Radio Module (A or B) as well as the presence of a Major or Minor Alarm.

Table 6-15. Alarm Module LEDs

LED Name	Behavior	Meaning
ALARM MAJ.	RED	On—Major Alarm (Master Station)
ALARM MIN.	RED	On—Minor Alarm (Master Station)
ACT A	BLUE	On—Radio A Active Off—Radio A Standby
ACT B	BLUE	On—Radio B Active Off—Radio B Standby

Alarm/Audio Interface

The ALARM/AUDIO Interface on the Alarm/Relay module provides audio signaling and alarm outputs as shown below.

AUDIO:

- 4-wire audio circuits are connected to pins 1 through 4 as shown in Figure 9.
- Terminals 1 and 2 are for transmit audio input with a nominal 600Ω impedance.
- Terminals 3 and 4 provide receive audio output with a nominal 600 Ω impedance.
- Pin 5 connects to an external keying source. Shorting pins 5 to pin 7 can key the radio when PTT LOW is configured in software. When PTT is configured high in software, pulling PTT to 3.3V keys the radio.

The interface is compatible with an external VOX adapter, although this product features an integrated VOX circuit with digital threshold control. For applications using the external VOX adapter, 12VDC on pin 6 can be used to power the external module.

ALARMS:

- Terminals 8 and 9 provide solid state relay contacts that close when a minor alarm is detected.
- Terminals 10 and 11 provide relay contacts that close when a major alarm is detected. You can redefine these relay contacts using the radio's software (switched from minor to major alarm outputs, or vice versa). The contacts are rated for non-inductive loads up to a maximum 60 Volts (AC or DC) at 1 A.

Analog RSSI:

When enabled in software, an RSSI voltage of 0 to 3V corresponding to -120 to -70dBm is present on this line.

+12v	6	<input type="checkbox"/>	<input type="checkbox"/>	12 Analog RSSI
PTT	5	<input type="checkbox"/>	<input type="checkbox"/>	11 Major Alarm Contact
Rx Audio -	4	<input type="checkbox"/>	<input type="checkbox"/>	10 Major Alarm Contact
Rx Audio +	3	<input type="checkbox"/>	<input type="checkbox"/>	9 Minor Alarm Contact
Tx Audio -	2	<input type="checkbox"/>	<input type="checkbox"/>	8 Minor Alarm Contact
Tx Audio +	1	<input type="checkbox"/>	<input type="checkbox"/>	7 Ground

Figure 6-9: Alarm/Audio Connections

(As viewed from outside the radio)

Alarm/Relay Toggle Switch (6847 Only)

For redundant units, the Alarm/Relay module includes a manual override toggle switch, which can be set into one of three positions to associate it with a particular radio. The toggle switch is locking, and must be pulled out to change positions. Switch functions are as follows:

- **Up** — Radio A
- **Down** — Radio B
- **Center** — Automatic.

When the switch is set to Automatic, the active radio is determined by radio module presence and alarm status.

NOTICE If only one radio module is installed (A or B) it is recommended that the switch be set to A or B, as appropriate.

The non-redundant version of the Alarm Module does not include the Toggle Switch.

Alarm/Relay RF Connections (6847 Only)

For redundant systems, the Alarm/Relay module includes a RF Connections for both the A and B Radio Module, and RF OUT. These are all Dual FAKRA-SMB connectors. RF OUT is switched between Radio A and Radio B depending on the currently active radio. RF OUT is normally cabled to the Duplexer tray faceplate, even on systems that do not include a duplexer. Redundant systems come from the factory already properly cabled between the Radio Modules, Alarm/Relay Module and Duplexer tray faceplate. Connectors are keyed to ensure proper orientation.

Non-redundant systems using the 6848 Alarm Module do not include RF Connections.



6.6 Duplexer Tray

Current Master Station offerings always include a Duplexer tray whether or not an internal duplexer is included. This allows consistent cabling from either the Radio Module (non-redundant systems) or the Alarm/Relay Module (redundant systems) to the faceplate of the Duplexer tray. Wiring internal to the Duplexer Tray routes RF Signals to the antenna connections on the back of the Master Station as appropriate to the order configuration.

RF Connection to the front of the duplexer tray depends upon order configuration and frequency plan.

Table 6-16. Cabling to the Duplexer Tray Faceplate

Duplexer Option	Frequency Plan	Cable From - To	Antenna Connection on Back	Comment
Internal	TX > RX	TX - HIGH RX - LOW	COMBINED OUT	Cable by Frequency Plan to High/Low
Internal	TX < RX	TX - LOW RX - HIGH	COMBINED OUT	Cable by Frequency Plan to High/Low
Simplex	TX > RX TX = RX TX < RX	TX - HIGH RX - LOW	TX RX	Software configurable single or dual antenna port.
External	TX > RX TX < RX	TX - HIGH RX - LOW	TX RX	Wire TX to High always, independent of Frequencies



Older versions of the Duplexer Tray faceplate read **TX** instead of **High** and **RX** instead of **Low**. In this case, for configurations with internal duplexer in which the TX frequency is lower than the RX frequency, swap the cables on the Duplexer Tray such that TX is cabled to the port labelled RX and RX is cabled to the port labelled TX.

7.0 TROUBLESHOOTING

If trouble occurs with the unit, verify that it meets the basic requirements listed below. These items should be checked prior to starting any detailed troubleshooting or calling for assistance. All units must have:

- Adequate and stable primary power
- Secure cable and wiring connections
- Proper configuration for the application

Most radio system problems are due to the failure of components *outside* of the transceiver—such as a poor or broken feed line or antenna connection. This section will help you determine whether the problem is outside or inside the radio and, if in the radio, how to restore operation as quickly as possible.

GE MDS does not recommend component-level repairs in the field. However, you can replace the radio's major assemblies without using tools or test equipment. Section 7.4 Replacing Modules covers this in detail.



Before starting any detailed troubleshooting, check the basic requirements at both ends of the link: primary power, secure cable connections, and proper antenna heading. In many cases, one of these causes poor operation or a complete loss of link service.

7.1 Interpreting Module LEDs

The LEDs on the front of installed modules provide useful information when troubleshooting. Refer to Section 6.0 Master Station Modules for detailed descriptions for module LEDs. Power and alarm indicators are provided on Platform Manager (Page 80), Radio (Page 85), and Alarm/Relay modules (Page 87). Radio Modules also have TX/RX LEDs to show wireless activity.

Normal Operation

During normal, operation, there should *not* be any Red LEDs illuminated. All illuminated LEDs should be BLUE or GREEN.

Table 7-1. Status LEDs – Normal Operation

Platform Manager	PWR	BLUE
	ALARM	OFF
	ETH1/ETH2	Flashing with Ethernet traffic
Active Radio Module	PWR/ALARM	GREEN
	ACTIVE	GREEN
	TX	Flashing BLUE when transmitting
	RX	Flashing BLUE when receiving
Standby Radio Module (if present)	PWR/ALARM	GREEN
	ACTIVE	OFF
	TX	OFF
	RX	OFF
Alarm Module	ALARM MAJ.	OFF
	ALARM MIN.	OFF
	ACT A & ACT B	One BLUE, one OFF

Exception and Alarm States

The first indication of a problem is usually an illuminated ALARM LED on one or more of the modules. The first place to look is the Alarm or Alarm/Relay module and see if the PWR/Alarm LED is RED.

Table 7-2. Status LEDs – Exception and Alarm States

Module	LED	Behavior	Meaning	Troubleshooting Action
Platform Manager	PWR	Flashing (BLUE)	Booting / System Initialization	Wait several minutes for system to boot.
Platform Manager	ALARM	Flashing (BLUE)	Master Station Alarm	Use Device Manager to determine Alarm
Radio Module	PWR/ALARM	Flashing GREEN	Radio power up	Wait several seconds for radio to boot.
Radio Module	PWR/ALARM & ACTIVE	Alternating	Radio Firmware update	Wait several minutes for firmware upgrade to complete.
Radio Module	PWR/ALARM	Flashing RED	Radio Alarmed	Use Device Manager to determine Alarm
Radio Module(s)	ACTIVE	Both/Only Modules OFF	No active radio in the system (Alarm/Relay Module may still indicate Active A or B)	Select Radio with A/B Toggle Switch. Return to Auto (Redundant System) Remove and re-seat radio module.
Both Radio Modules (Redundant Only)	ACTIVE	Both Modules GREEN	System ERROR - both radios active (Alarm/Relay Module may still show only one active)	Select Radio with A/B Toggle Switch. Return to Auto Remove and re-seat one or both radio modules.
Alarm Module	ALARM MAJ. ALARM MIN.	RED	Master Station Major or Minor Alarm.	Use Device Manager to determine Alarm

7.2 Redundant Units

The active radio can be identified by the corresponding LED on the alarm/relay module as well as the active LED on the radio module. The active unit is normally selected automatically. For troubleshooting, the toggle switch can be used to manually set the active radio. Alternatively, the switch can remain in the automatic position, and the active radio can be selected via the SD Manager UI.

7.3 Technical Assistance

Factory technical assistance is available by contacting GE MDS during business hours (8:30 AM to 6:00 PM Eastern Time). For telephone assistance, call (585) 241-5510, or visit our website at www.gemds.com for additional contact options.

7.4 Replacing Modules

Component-level repair of a transceiver board in the field is not recommended due to the complex nature of the circuitry and the use of surface-mount technology throughout the radio. You should return malfunctioning assemblies to the factory (or authorized service center) for repair or replacement.

One approach to field-level servicing is to have spare modules available. Slide in modules are easily field replaceable, including Power Supply, Radio, Platform Manger, and Alarm/Relay Modules. Internal Duplexers can also be replaced in the field. In this way, you can quickly remove and replace a defective assembly with a working assembly. The following instructions describe the removal and installation of these assemblies.

NOTICE When installing Power Supply or Radio Modules, torque thumbscrews to 10 in-lbs to insure optimum heat transfer through thermal contact connector on the rear of the unit.

Power Supply Modules

The two left-most card-slots on the MDS™ Master Station are dedicated to Power Supply Modules. To remove either of these assemblies, first disconnect the power supply cable. Loosen the two thumbscrews on the front of the module, then slide the module straight out.

A Power Supply Module can be installed in either of the left-most slots on the Master Station. It will not engage if an attempt is made to install into any other slot in the chassis. To install, align the Module with the card guides and slide into the chassis until it engages with the backplane connectors. Push firmly on the faceplate of the module to ensure a good connection and hand-tighten the thumb screws. The thumb screws should be further tightened to 10 in-lbs to ensure optimum heat transfer through thermal contact connector on the rear of the unit.

Connect the power cable first making certain that the supply is within the rating for the power supply module you have installed.

Table 7-3. Power Supply Modules

Module ID	Module	Module Description
MDS 05-6399A01, Rev. E		MDS™ Master Station



6755	100-220 AC Power Supply Module	100-220 VAC, 50/60 Hz. 120W Max AC Power Supply Module.
6843	+/- 12-36 VDC Power Supply Module	+/- 12-36 VDC. 10 A Max. DC Power Supply Module.
6844	+/- 36-75 VDC Power Supply Module	+/- 36-75 VDC. 3.5 A Max DC Power Supply Module.
6845	+/- 75-140 VDC Power Supply Module	+/- 75-140 VDC. 2 A Max DC Power Supply Module.

CAUTION DC power supply modules are available for several different input ranges. These modules have interchangeable connectors. Make sure the supply is within the rating for the module installed.

On a redundant unit equipped with two power supplies, a supply can be removed, and a new supply can be installed, while the unit is powered and operational. Do not remove power supplies whose power source is still connected and active.

Peripheral Modules – including Platform Manager, Radio, Alarm, and Alarm Relay Modules.

Peripheral slots on the Master Station include all slots between the power supply modules (on the left) and the duplexer tray (on the right). On an MDS™ Master Station, the peripheral slots are populated with the following modules, from left to right: Platform Manager, Radio Module, a second Radio Module if redundant, and an Alarm Module or Alarm/Relay Module if redundant.

To remove peripheral modules, first disconnect cables attached to the faceplate of the module you are removing. Label connections if necessary to remember how connections are made. Loosen the two thumbscrews on the front of the module, then slide the module straight out, moving other cables out of the way as necessary.

CAUTION The Radio Module heat spreader gets very hot under normal operating conditions. Always use caution handling recently powered Radio Modules. When removing a Radio Module, **do not touch the heat spreader**. It is recommended to pull the Radio Module out only part way, disengaging the module from the backplane and rear heatsink, and then allow the Radio Module to cool for several minutes before removing it fully from the chassis.

To install a peripheral module, align the module with the card guides and slide into the chassis until it engages with the backplane. Push firmly on the faceplate of the module to ensure a good connection and hand-tighten the thumb screws. The thumb screws can be further tightened with a screwdriver. Radio Modules should be tightened to 10 in-lbs to ensure optimum heat transfer through thermal contact connector on the rear of the unit. Reconnect faceplate cabling connections to other modules as necessary.

Hot Swap Redundant Modules

On a redundant unit equipped with two Power Supplies and two Radio Modules, these modules can be removed and/or installed while the unit is powered and operational. Replacing a Power

Supply *does* require first removing the supply input for the module, but the alternate Power Supply can remain powered. The unit will continue to operate using a single power supply.

When removing a Radio Module on a redundant unit, we recommend changing the selector switch on the Alarm/Relay Module to lock the active radio to A or B as appropriate before removing the other Radio Module. This should be done even if the desired radio is already active. The manual override toggle switch is locking, and must be pulled out to change positions. Switch functions are as follows:

- **Up** —Radio A;
- **Down** — Radio B;
- **Center** — Automatic.

Once a new Radio Module is installed, the Select Switch should be returned to the Center (Automatic) position for redundant operation.

Internal Duplexer Tray

The duplexer tray can be removed by first removing two screws on the top of the chassis holding the tray in place. Save these screws. Disconnect all cabling to both the faceplate of the duplexer and on the back of the unit. Once cabling and screws have been removed, push on the connectors on the back of the unit to free the tray from the chassis and then slide out the front. To install a new tray, slide the tray in allowing the connectors to push through the back of the chassis. Use the same screws to secure the front of the tray to the chassis and then reconnect cabling being careful to connect TX and RX cables from the Alarm Module to the correct faceplate connections on the Duplexer Tray.

MDS SDM4—400 MHz Notch-Type Duplexers

You can generally change the radio's transmit frequency up to 100 kHz without re-tuning the duplexer. The duplexers shown in Figure 7-1. 400 MHz Notch Duplexer can be aligned in the field by experienced technicians using high-quality test equipment. For assistance, contact GE MDS Technical Support for additional details about tuning.

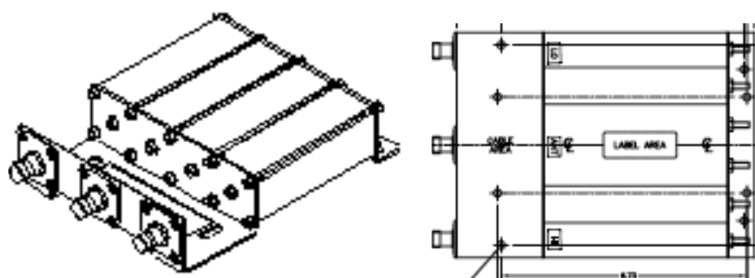

Figure 7-1. 400 MHz Notch Duplexer

(Adjustment generally not required for transmit changes up to 100 kHz)

NOTICE Duplexer alignment is a sophisticated procedure and a duplexer can be easily damaged if not handled carefully. It is highly recommended that you return duplexers needing realignment to GE MDS, or the original duplexer manufacturer, for alignment. In some cases, it may be more economical to replace the unit than to have it



realigned.

MDS SDM9—Bandpass-Type Duplexers

These duplexers (Figure 7-2. 900 MHz Bandpass Duplexer) typically allow the transmitter frequency to change up to 500 kHz without undesired results. Since this type of duplexer cannot be re-aligned in the field, we recommend contacting the GE MDS Technical Support Department if you suspect a duplexer problem or need one for a different frequency.

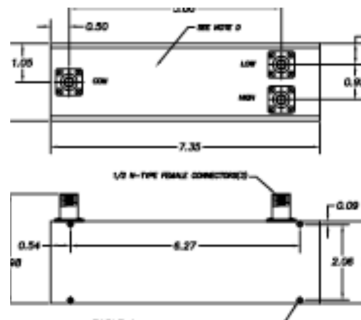

Figure 7-2. 900 MHz Bandpass Duplexer

(Adjustment generally not required for transmit changes up to 500 kHz)

7.5 Testing and Removing an Internal Duplexer

Testing

If you suspect that the internal duplexer is not functioning properly, perform the following steps to determine if requires replacement:

1. Measure the RF power out of the antenna jack.
 - If the power registers approximately +37 dBm (5 watts), the internal duplexer is probably functioning correctly (see **Table 8-1. dBm–Volts–Watts Conversion Chart** for dBm-volts-watts conversion chart).
 - If the power registers significantly less than +37 dBm, proceed with Step 2.
2. Locate the TX SMA connection on the front of the duplexer tray.
3. Using an adapter, connect the RF power meter to the SMA Cable on the front of the unit
 - If the power registers +39 dBm, the radio board is functioning correctly.
 - If the power registers less than +39 dBm, proceed with Step 4.
4. Use the front panel to switch to the alternate transmitter and again measure the RF power output.
 - If the alternate transmitter registers +39 dBm, the internal duplexer probably needs replacing.
5. Before replacing the duplexer, verify that the highest or lowest frequencies marked on the duplexer are the same as radio's transmit and receive frequencies or within the nominal operating range: 100 kHz for 400 MHz radios, and 500 kHz for 900 MHz radios.

Removing the Internal Duplexer

To remove the internal duplexer, follow these steps:

Disconnect the antenna cables from the back of the chassis.

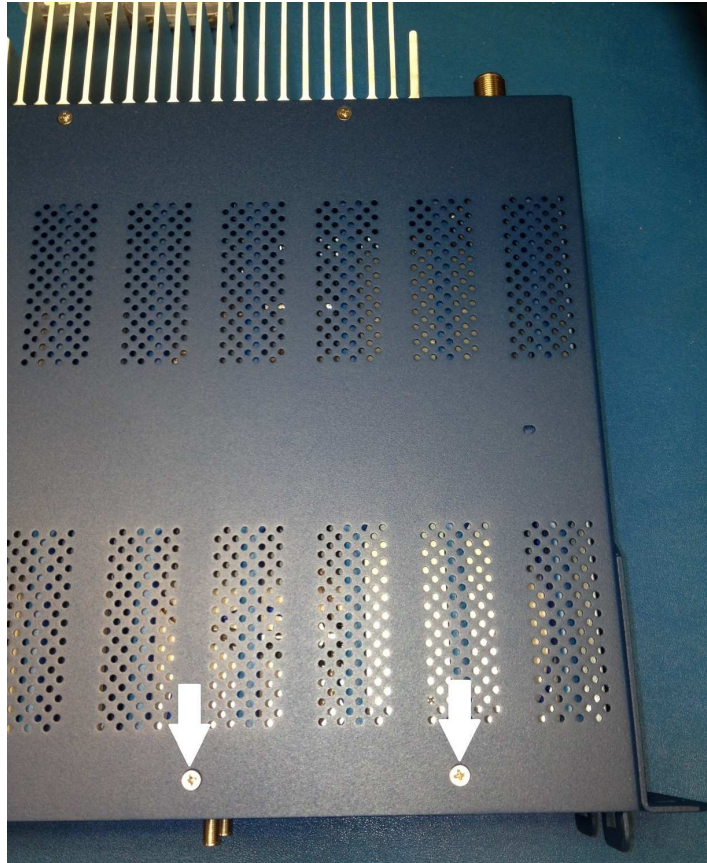

Internal Duplexer Cabling - A number of different duplexers can be installed in the radio. While the physical appearance of the duplexer may vary slightly, its operation and removal remain the same.

Disconnect the SMA cables from the front of the duplexer tray

Remove the two screws on the top of the unit that secure the duplexer tray into the front of the chassis.

Carefully slide the duplexer tray out the front of the chassis by applying pressure to the antenna N-connectors on the rear of the unit.

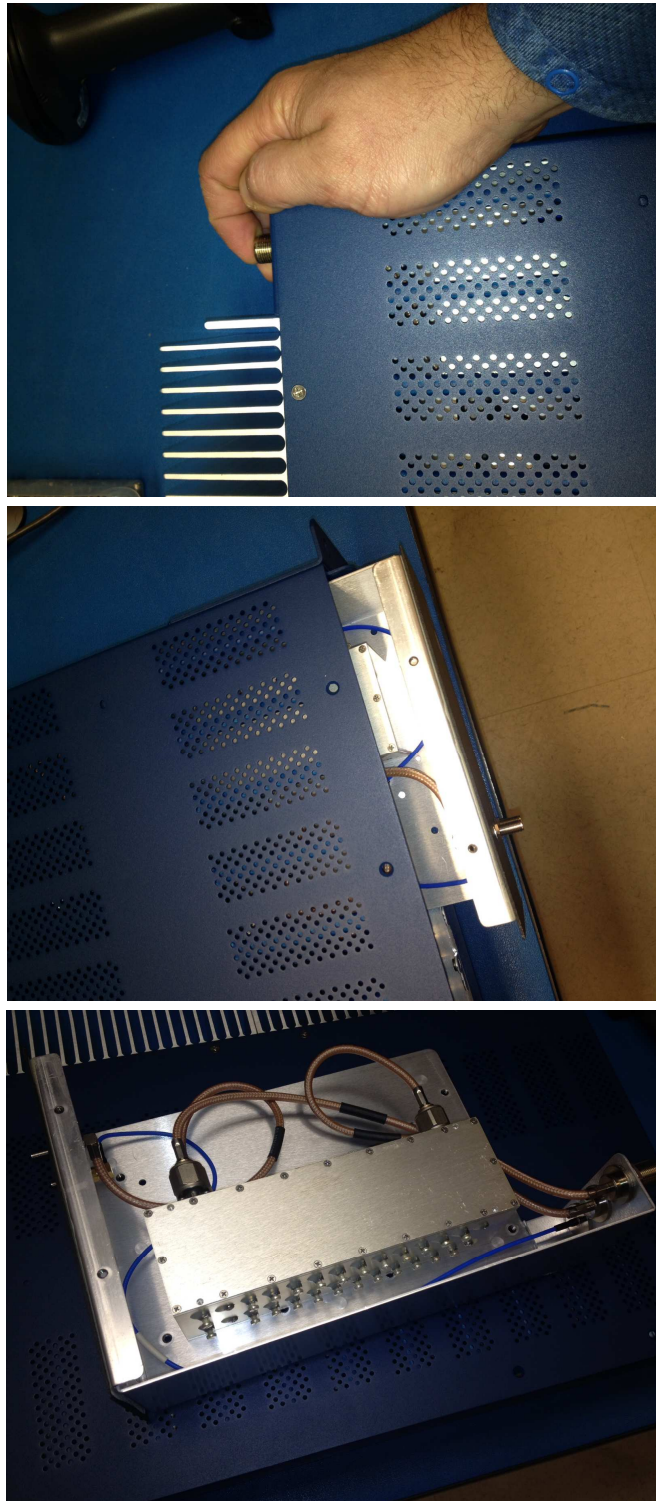

Remove four screws to remove the duplexer assembly from the tray

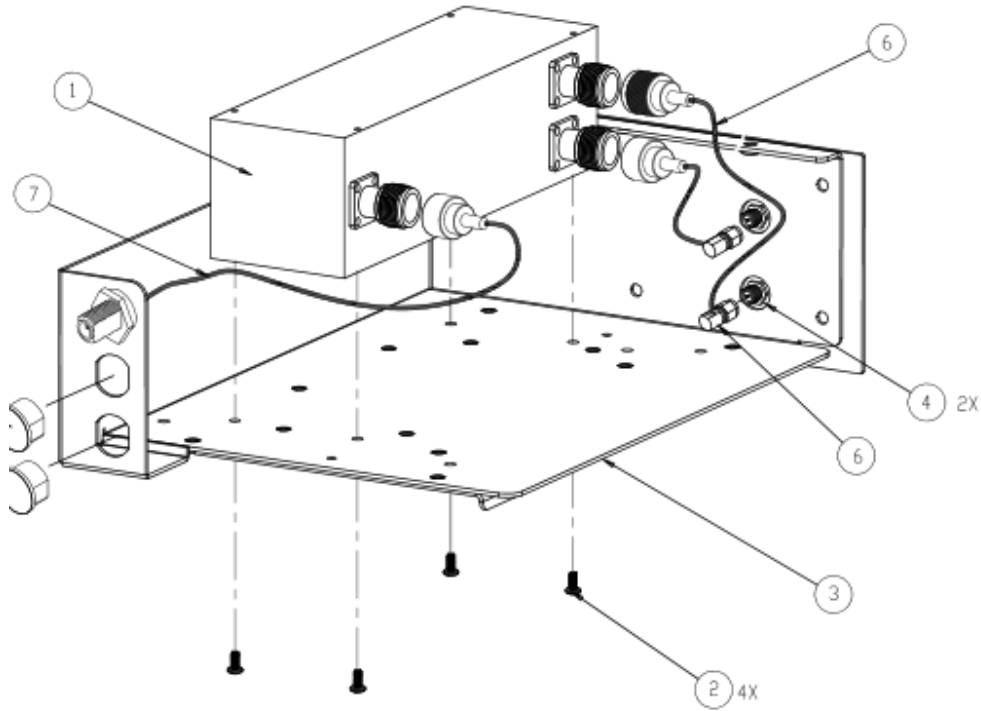

Figure 7-3. Internal Duplexer Removal

NOTICE

Use care when removing the duplexer. Physical damage may cause detuning.



8.0 TECHNICAL REFERENCE DATA

8.1 RF Propagation Planning

Establishing a reliable point-to-point radio link requires system planning and design. You should have an understanding of the physical parameters affecting propagation. The following material discusses these factors and will assist you in designing a dependable transmission path for your radio link.



This section is intended for use as a guideline when planning transmission paths. It does not consider all of the local conditions that may be present, nor does it guarantee that adequate signal strength will be obtained in a given system. There is no substitute for an on-the-air test to verify the predicted path results, and to check the overall operation of the radio system.

To ensure a highly reliable path, a line of sight between both ends of the link is desirable. For short paths (up to 5 kilometers/3.1 miles), some obstructions might be acceptable, but the performance of a blocked path is always less predictable than a clear path.

Fresnel Zone Clearance

As the distance spanned by a link gets longer, it is necessary to have more than just a grazing path between the two ends; the path must clear the ground or other obstacles by some percentage of a Fresnel zone.

The Fresnel zone corresponds to the width or girth of the radio signal. There are first, second, and third Fresnel zones, but the first zone is the only one that has substantial effects on signal strength.

The first Fresnel zone can be visualized as an oval-shaped volume between two station antennas (Figure 8-1). As the width of the radio wave front gets blocked by obstructions, less of the signal can get to the receiver antenna.

In addition to blocking the signal, obstructions in the first Fresnel zone may also cause multipath interference due to reflective and refractive signal paths. The reflected or refracted signal might arrive at the receiver out of phase with the desired signal and cause a canceling effect.

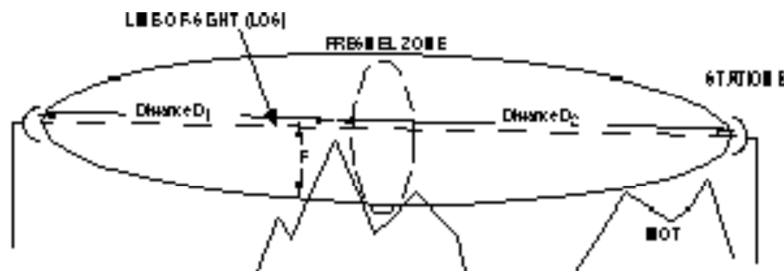

Figure 8-1 Fresnel Zone Obstructions

As a matter of practice, 60 percent of the first Fresnel zone must be clear of obstructions ($0.6 \times F$) to allow a clear, unobstructed RF path.

Remember, the first Fresnel zone calculation is only one parameter determining path quality.

Earth Curvature

As the distance of a communication link increases, the clearance problem is compounded by the earth's curvature. Radio waves traveling through typical atmospheric conditions bend slightly, which is represented by treating the earth as though it were slightly flatter than it actually is. Experience has shown that if we consider the earth's radius 4/3rds of its actual size, we get good agreement between theory and measured propagation results.

The figure below shows a representation of the 4/3 earth "radio horizon." This figure shows that under normal radio propagation conditions, a station with its antenna 15 meters above flat terrain will have a radio horizon approximately 15 kilometers away, well beyond the visual horizon.

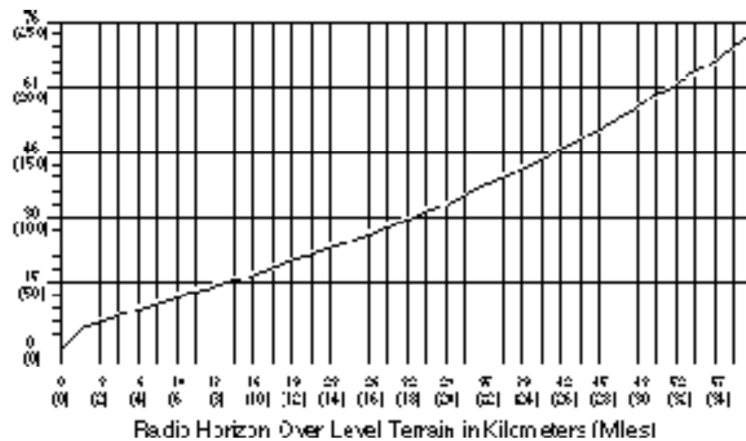

Figure 8-2. Antenna Height vs. Theoretical Radio Horizon

Fade Margins

Variations in the temperature and humidity of the atmosphere with elevation cause the signals to bend more or less, resulting in fading at the receiver. The longer the path, the more likely that deep fades will occur, hence the greater the fade margin required.

Different parts of the world have differing propagation conditions, which can be categorized as favorable, average, or adverse. In general, mountainous areas have favorable propagation conditions, while tropical areas and those near large bodies of water have adverse conditions.

Calculating Path Loss

Assuming that we have satisfied the line-of-sight and first Fresnel zone clearance requirements, we can calculate the path loss. At 450 MHz, the loss between two isotropic radiators (0 dBi antennas) that are 1 km apart is 86 dB. For every doubling of distance, the loss increases by an additional 6 dB. Knowing this, the output power (+37 dBm), and the receiver sensitivity, we can calculate antenna size and tower height requirements to cover any desired distance.

Formulas for System Planning

The following standard formulas are provided for assistance in determining system installation parameters.

Free Space Path Loss

$$\alpha_{fs} = 92.4 + 20 \log_{10} f + 20 \log_{10} d \quad \text{where:}$$

α_{fs} = free space loss in dB
 d = path distance in kilometers



f = frequency in GHz

Fresnel Zone Boundary

$$F_n = 17.3 \sqrt{\frac{nd_1 \cdot d_2}{fD}}$$

where:

F_n = Fresnel zone boundary in meters

d_1 = distance from one end of the path to the Fresnel zone boundary (in kilometers)

d_2 = distance from the other end of the path to the Fresnel zone boundary (in kilometers)

D = total path distance (d_1+d_2) in kilometers

f = frequency in GHz

n = Fresnel zone, 1 (for 1st) is used here

Theoretical Signal Strength

$$RSSI = EIRP - \alpha_{fs} + G_{ra} - L_{rfl} \quad \text{where:}$$

RSSI = signal strength at the receiver in dBm

EIRP = RF power output in dBm + $G_{ta} - L_{tfl}$

α_{fs} = free-space path loss in dB

G_{ra} = receive antenna gain in dBi

L_{rfl} = receive feedline loss in dB

L_{tfl} = transmit feedline loss in dB

G_{ta} = transmit antenna gain in dBi

Probability of System Fading

$$FProb = a \times b \times 6.0 \times 10^{-7} \times f \times d^3 \times 10^{(-F)/10} \quad \text{where:}$$

$FProb$ = probability of fading more than F

a = terrain factor

- 4 is used for very smooth terrain, such as over water
- 1 is used for average terrain, with moderate roughness
- 0.25 is used for mountainous or very rough terrain

b = climate factor

- 0.5 is used for a hot, humid climate
- 0.25 is used for temperate or northern areas
- 0.125 is used for a very dry climate

f = frequency in GHz

d = path length in km

F = fade margin in dB



9.0 GLOSSARY OF TERMS & ABBREVIATIONS

If you are new to wireless data systems, some of the terms in this guide may be unfamiliar. The following glossary explains many of these terms and can prove helpful in understanding the operation of the Master Station. While some entries may not appear specifically in the text of this manual, they are included to promote a more complete understanding of wireless data networks, both of current and legacy design.

Active Messaging—This is a mode of diagnostic gathering that may interrupt payload system polling communications (contrast with *passive messaging*). Active (or intrusive) messaging is faster than passive messaging because it is not dependent upon the RTU polling cycle.

Antenna System Gain—A figure, normally expressed in dB, representing the power increase resulting from the use of a gain-type antenna. System losses (from the feedline and coaxial connectors, for example) are subtracted from this figure to calculate the total antenna system gain.

BER—Bit Error Rate.

Bit—The smallest unit of digital data, often represented by a one or a zero. Eight bits (plus start, stop, and parity bits) usually comprise a byte.

Bits-per-second—See *BPS*.

BPS—Bits-per-second. A measure of the information transfer rate of digital data across a communication channel.

Bridging—(see Ethernet Bridging).

Byte—A string of digital data usually made up of eight data bits and start, stop and parity bits.

Ckeyed—Pertains to *continuously keyed* Master stations (full-duplex).

CLI—Command Line Interface. A method of user control where commands are entered as character strings to set configuration and operating parameters.

CTS—Clear to Send.

Decibel (dB)—A measure computed from the ratio between two signal levels. Frequently used to express the gain (or loss) of a system.

Data Circuit-terminating Equipment—See *DCE*.

Data Communications Equipment—See *DCE*.

Data Terminal Equipment—See *DTE*.

dB_i—Decibels referenced to an “ideal” isotropic radiator in free space. Frequently used to express antenna gain.

dB_m—Decibels referenced to one milliwatt. An absolute unit used to measure signal power, as in transmitter power output, or received signal strength.

DCE—Data Circuit-terminating Equipment (or Data Communications Equipment). In data communications terminology, this is the “modem” side of a computer-to-modem connection. The transceiver described in this manual is hardwired as a DCE device.

Digital Signal Processing—See *DSP*.

DLINK—Data Link Mode. This is a GE MDS-proprietary protocol used when the transceiver is in diagnostics mode.

DSP—Digital Signal Processing. The transceiver’s DSP is the core operating unit of the transceiver through which nearly all functions depend.

DTE—Data Terminal Equipment. A device that provides data in the form of digital signals at its output. Connects to the DCE device.

ETH—Abbreviation for Ethernet.

Ethernet Bridging—A mode of operation for the transceiver where the radio decides whether messages are handled locally or sent intact over-the-air.

Fade Margin—The greatest tolerable reduction in average received signal strength expected under most conditions. Provides an allowance for reduced signal strength due to multipath fading, slight antenna movement or changing atmospheric losses. A fade margin of 20 to 30 dB is usually sufficient in most systems.

FPGA—Field Programmable Gate Array.

Frame—A segment of data that adheres to a specific data protocol and contains definite start and end points. It provides a method of synchronizing transmissions.

Gate—An operating mode of the transceiver with respect to diagnostic/management activities. See also NODE, PEER, and ROOT.

Hardware Flow Control—A transceiver feature used to prevent data buffer overruns when handling high-speed data from the RTU or PLC. When the buffer approaches overflow, the radio drops the clear-to-send (CTS) line, which instructs the RTU or PLC to delay further transmission until CTS again returns to the high state.

Host Computer—The computer installed at the master unit, which controls the collection of data from one or more remote sites.

I/O—Input/Output.

IP—Internet Protocol.

Intrusive Diagnostics—A mode of remote diagnostics that queries and commands radios in a network with an impact on the delivery of the system “payload” data. See *Active messaging*.

LAN—Local Area Network.

LED—Light Emitting Diode.

Latency—The delay (usually expressed in milliseconds) between when data is applied to the TXD pin at one radio, until it appears at the RXD pin of another radio.

Listen Before Transmit—A collision avoidance mechanism that attempts to allow transmission only when the channel is clear.

mA—Milliamperes (current flow). 1000 mA = 1 Ampere.

MAC—Media Access Control.

NIC: Network Interface Card. This is another name for the modules that are selectively included in the product based on order entry.

NX915: A GE MDS NIC module supporting unlicensed operation at 900 MHz

MAS—Multiple Address System. A radio system where a central master unit communicates with several remote stations for the purpose of gathering telemetry data.

Master (Station)—Radio which is connected to the host computer. It is the point at which polling enters the network.

Multiple Address System—See *MAS*.



Network-Wide Diagnostics—An advanced method of controlling and interrogating GE MDS radios in a radio network.

Node—An operating mode of the transceiver with respect to diagnostic/management activities. See also GATE, PEER, and ROOT.

Non-intrusive diagnostics—See *Passive messaging*.

OTA—Over-the-Air.

PA—Power Amplifier.

Packet Radio—A transmission scheme in which data elements are assembled into units, that are consecutively numbered and error-checked at the time of transmittal. Errored packets result in retry requests from the receiving station.

Passive messaging—This is a mode of diagnostic gathering or reprogramming that does not interrupt payload system polling communications. Diagnostic/reprogramming data is sent/collected non-intrusively over a period of time; polling messages are carried with payload system data (contrast with *active messaging*).

Payload data—This is the application's communication data which is sent over the radio network.

Peer—An operating mode of the transceiver with respect to diagnostic/management activities. See also GATE, NODE, and ROOT.

Point-Multipoint System—A radio communications network or system designed with a central control station that exchanges data with a number of remote locations equipped with terminal equipment.

Poll—A request for data issued from the host computer (or master PLC) to a remote radio.

PLC—Programmable Logic Controller. A dedicated microprocessor configured for a specific application with discrete inputs and outputs. It can serve as a host or as an RTU.

PPM—Parts per Million. Typically used to specify a tolerance rating for an operational parameter.

Programmable Logic Controller—See *PLC*.

Remote (Station)—A radio in a network that communicates with an associated master unit.

Remote Terminal Unit—See *RTU*.

Redundant Operation—A station arrangement where *two* transceivers and two power supplies are available for operation, with automatic switch-over in case of a failure.

Root—An operating mode of the transceiver with respect to diagnostic/management activities. See also GATE, NODE, and PEER.

RTS—Request-to-send.

RTU—Remote Terminal Unit. A data collection device installed at a remote radio site. An internal RTU *simulator* is provided with the transceiver to isolate faults to either the external RTU or the radio.

RX—Abbreviation for “Receive.” See also TX.

SAF—Store and Forward. An available feature of the radio where data is stored by a designated Remote, and then retransmitted to a station beyond the communication range of the AP.

Signal-to-Noise Ratio—See *SNR*.

SCADA—Supervisory Control And Data Acquisition. An overall term for the functions commonly provided through an MAS radio system.

SCEP (Simple Certificate Enrollment Protocol): A scalable protocol for networks based on digital certificates, which can be requested by users without the need for assistance or manual intervention from a system administrator.

SNR—Signal-to-Noise ratio. A measure of how well a signal is being received relative to noise on the radio channel.

SSH: Secure Shell protocol for a network that allows users to open a window on a local PC and connect to a remote PC as if they were present at the remote.

SSID (Service Set Identifier): A name that identifies a particular 802.11 wireless LAN.

Standing Wave Ratio—See *SWR*.

Supervisory Control And Data Acquisition—See *SCADA*.

SWR—Standing Wave Ratio. A parameter related to the ratio between forward transmitter power and the reflected power from the antenna system. As a general guideline, reflected power should not exceed 10% of the forward power ($\approx 2:1$ SWR maximum).

Telnet—A terminal emulation protocol that enables an Internet user to communicate with a remote device for management activities as if it were locally connected to a PC.

Terminal Server—An available feature on the radio which encapsulates serial data from the COM1/COM2 ports, and sends it over the air as IP packets. The data is decapsulated at the receiving end and routed to the appropriate COM ports.

Transparent Mode—A mode in which payload data remains unchanged from its original format when it is sent over the air. A radio in this mode is said to be “transparent” to connected equipment at each end of a link.

TX—Abbreviation for “Transmit.” See also RX.

VLAN—Virtual Local Area Network

WAN—Wide Area Network

x710—The generic name for GE MDS legacy transceiver-family products, including the MDS 9710 (900 MHz), MDS 4710 (400 MHz), 2710 (200 MHz) and MDS 1710 (100 MHz).

IN CASE OF DIFFICULTY...

Our products are designed for long life and trouble-free operation. However, this equipment, as with all electronic equipment, may have an occasional component failure. The following information will assist you in the event that servicing becomes necessary.

TECHNICAL ASSISTANCE

Technical assistance for GE MDS products is available from our Technical Support Department during normal business hours (8:30 A.M.–6:00 P.M. Eastern Time). When calling, please give the complete model number of the product, along with a description of the trouble/symptom(s) that you are experiencing. In many cases, problems can be resolved over the telephone, without the need for returning the unit to the factory. Please use one of the following means for product assistance:

Phone: (585) 241-5510

E-Mail: gemds.techsupport@ge.com

FAX: (585) 242-8369

Web: www.gemds.com

REPAIR SERVICE

Component level repair of this equipment is not recommended in the field. Many components are installed using surface mount technology, which requires specialized training and equipment for proper servicing. For this reason, the equipment should be returned to the factory for any PC board repairs. The factory is best equipped to diagnose, repair and align your unit to its proper operating specifications.

If return of the equipment is necessary, you must obtain a return authorization number before shipment. This number helps expedite the repair so that the equipment can be returned to you as quickly as possible. Please be sure to include the number on the outside of the shipping box, and on any correspondence relating to the repair. No equipment will be accepted for repair without an authorization number.

Return authorization numbers are issued online at www.gedigitalenergy.com/Communications.htm. On the left side of the page, click “Login to my MDS” and once logged in, click “Service Request Order”. Your number will be issued immediately after the required information is entered. Please be sure to have the model number(s), serial number(s), detailed reason for return, “ship to” address, “bill to” address, and contact name, phone number, and fax number available when requesting a number. A purchase order number or pre-payment will be required for any units that are out of warranty, or for product conversion.

If you prefer, you may contact our Product Services department to obtain an authorization number:

Telephone Number: 585-241-5540

Fax Number: 585-242-8400

E-mail Address: gemds.productservices@ge.com

The radio must be properly packed for return to the factory. The original shipping container and packaging materials should be used whenever possible. All factory returns should be addressed to:

**GE MDS, LLC
Product Services Department
175 Science Parkway
Rochester, NY 14620 USA**

When repairs have been completed, the equipment will be returned to you by the same shipping method used to send it to the factory. Please specify if you wish to make different shipping arrangements. To inquire about an in-process repair, you may contact our Product Services department using the telephone, Fax, or E-mail information given above.

REPLACEMENT PARTS

Many spare and replacement items are available for purchase by contacting your factory sales representative, or by visiting our online store at <http://store.gedigitalenergy.com/front.asp>.



Digital Energy
MDS

GE MDS, LLC
175 Science Parkway
Rochester, NY 14620
Telephone: +1 585 242-9600
FAX: +1 585 242-9620
www.gemds.com

